

# Centair

## CMEV.4e / CMEV.4eHT

### Mechanical Extract Ventilation (MEV) System

### Installation Instructions



**Commissioning Data:**

To be completed by the Commissioning Engineer.  
Refer to User/Homeowner Guide also supplied.

# Contents

	Page	
<b>1.0</b>	<b>General Description / Physical Specification</b>	<b>2</b>
<b>2.0</b>	<b>Installation Instructions</b>	<b>3</b>
2.1	General Preparation	3
2.2	Positioning / Application	3
2.3	Mounting	4
2.4	Ducting Guidelines	5
2.5	Electrical	5
2.8	On Site Commissioning	9
3.0	Declaration of Performance (DOP)	11
<b>4.0</b>	<b>Guarantee</b>	<b>12</b>



## 1.0 General Description / Physical Specification

### 1.1 Overview

- 1.1.1 The CMEV.4e range is a ventilation system designed to provide improved indoor air quality in dwellings. As a whole house system, the unit constantly extracts air from rooms generating moisture and odours in dwellings (Kitchens, Wet Rooms, Utility Rooms and WC's).
- 1.1.2 A boost speed facility is provided to increase the ventilation rate during peak times, providing a comfortable indoor environment. A boost switch (not supplied) should be wired to provide this operation (see section - 2.5 Electrical).
- 1.1.3 These products feature on PCDB and part of the process requires the Installation Checklist for MEV products to be completed and submitted to building control, available at [www.ncm-pcdb.org.uk](http://www.ncm-pcdb.org.uk), along with all other relevant paperwork.
- 1.1.4 Record sheets for commissioning information are provided; please refer to section 4 of the User / Homeowner Guide also supplied with the product.
- 1.1.5 These instructions cover the following units –
- **CMEV.4e** – **Low Energy Version** - 2 or 3 speed depending on wiring & sensor configuration (see page 6).
  - **CMEV.4eHT** – **Low Energy with Greenwood HumidiSMART™ and Greenwood TimerSMART™ Technology** - 2 or 3 speed depending on wiring & sensor configuration (see page 6).
- 1.1.6 Packaging Includes –** 1 x CMEV.4e or CMEV.4eHT Unit  
2 x Spigot Blanking Caps  
1 x Installation Instructions  
1 x User/Homeowner Guide
- 1.1.7 Ancillary Items Required – 100 / 125mm round ducting or flat duct (204 x 60mm), 125 / 100mm Grilles & appropriate Boost Switch (GS1 or GS2).
- 1.1.8 **Warning:** This appliance can be used by children aged from 8 years and above and persons with reduced physical, sensory or mental capabilities or lack of experience and knowledge if they have been given supervision or instruction concerning use of the appliance in safe way and understand the hazards involved. Children shall not play with the appliance. Cleaning and user maintenance shall not be made by children without supervision.
- 1.1.9 Where an open-flued oil or gas-fuelled appliance is installed, precautions must be taken to avoid a back-flow of gases into the room.
- 1.1.10 The design, material specification and installation must only be carried out by “competent persons”. Electrical installation must be carried out by a qualified Electrician.

- 1.1.11 If the supply cord is damaged, it must be replaced by a special cord / assembly available from the manufacturer or its service agent. The replacement must be carried out by a qualified electrician in accordance with IEE or local regulations.
- 1.1.12 Observe appropriate safety precautions if working on steps or ladders. Wear eye protection when breaking out wall or window materials, etc.
- 1.1.13 To disassemble the unit, disconnect from mains supply and use a screwdriver to segregate the electronic components and motor from the plastic housing. Dispose items in accordance with WEEE.

1.1.14 **WEEE Statement**

This product may not be treated as household waste. Instead it should be handed to an appropriate collection point for the recycling of electrical and Electronic equipment.

For more detailed information about the recycling of this product, please contact your local council office or your household waste disposal service.



## 1.2 Physical Specification

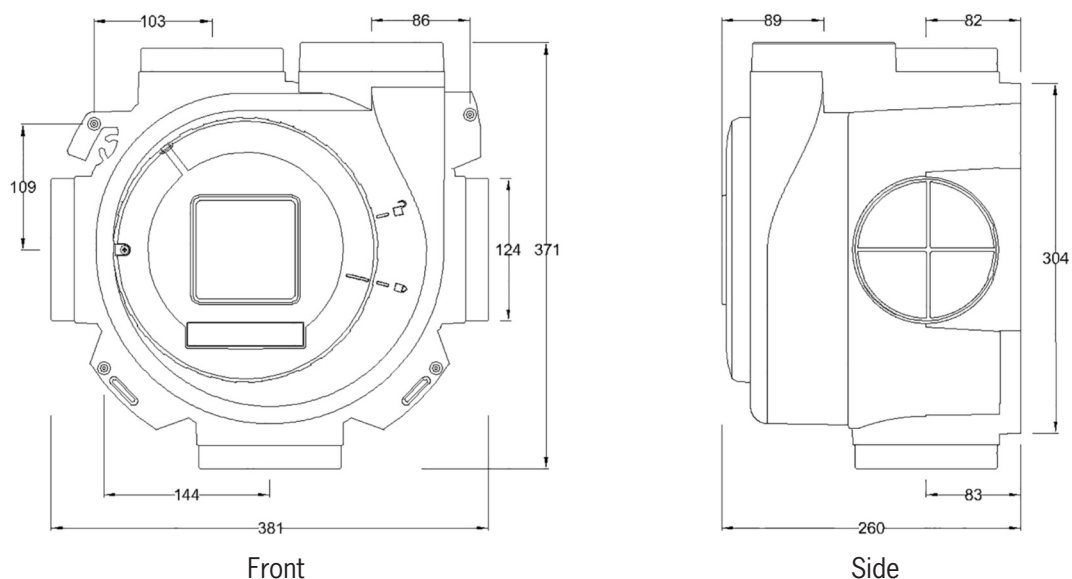

# 2.0 Installation Instructions

## 2.1 General Preparation

- 2.1.1 The CMEV.4e range of units are supplied with 5 x 125mm ducting spigots for connection of ducts to the unit for installation and 2 x blanking caps to close or block off unused spigots. One inlet spigot is located under the base of the unit and is supplied blanked off. For installations requiring fifth inlet port, proceed to cut out the spigot blank and connect duct. (See Figure 1).
- 2.1.2 125mm duct should be used to provide the best performance levels required for compliance with building regulations. The CMEV.4e range has been tested with both 125mm and 100mm round ducting. Note; Reducing ductwork to 100mm will increase system resistance and affect overall specific fan power ratings. Technical Services can be contacted on +44 (0) 1276 408402 should you have any questions in respect of this.
- 2.1.3 Installation of the unit should be in accordance with the current editions of Building Regulations and BS7671: IEE Wiring Regulations.
- 2.1.4 The design, material specification and installation must only be carried out by 'competent persons'. Electrical installation must be carried out by a qualified Electrician.

## 2.2 Positioning / Application

- 2.2.1 The unit can be installed in any plane and should be sited in a service cupboard, on a wall or ceiling or in a loft space (See Figure 2).
- 2.2.2 The unit must be securely mounted at each corner using either single or slotted fixing holes provided (See Figure 3).

Note; Fixing points have been designed to hold screws, for ease, when positioning/mounting the product to a surface.

2.2.3 Figure 1 - Optional Fifth Spigot

Carefully cut out spigot cap with a bladed tool

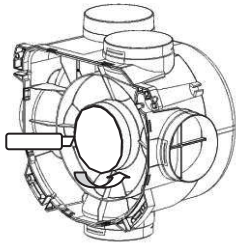

Discard waste material responsibly

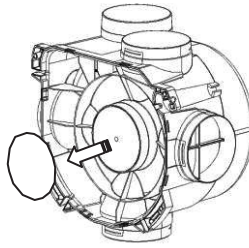

Connect ductwork as appropriate

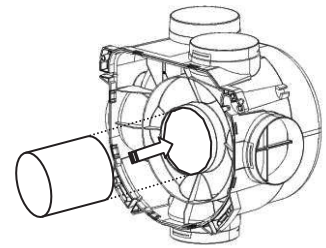

2.2.4 Figure 2 - Mounting Orientations

Ceiling Mounted in cupboard

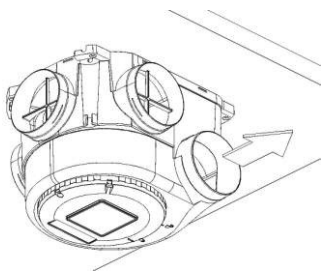

Wall Mounted

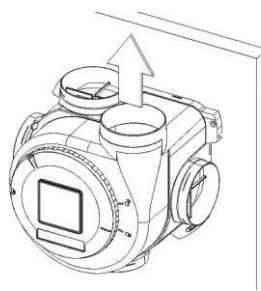

Loft Mounted on platform

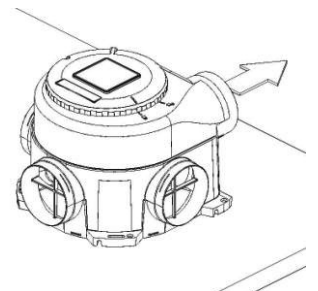

2.3 Mounting

2.3.1 Determine the duct inlet and exhaust configuration and the best orientation for the unit for this installation, also taking account of the access to the electrical services, and whether the fifth inlet port (supplied capped off) located on the unit base may assist with the dwelling/room layout.

2.3.2 Ensure there is adequate access for installation and eventual replacement (See Figure 4).

2.3.3 Once the fixing position and location have been determined, fit the blanking caps onto any unused spigots.

2.3.4 Securely mount the unit to the fixing surface with four screws (not supplied) and proceed to connect ducts.

Note; The fan can be fitted using one corner fixing and aligned if necessary using the slotted holes provided. (See Figure 3).

2.3.5 Figure 3 - Location of Fixing Holes

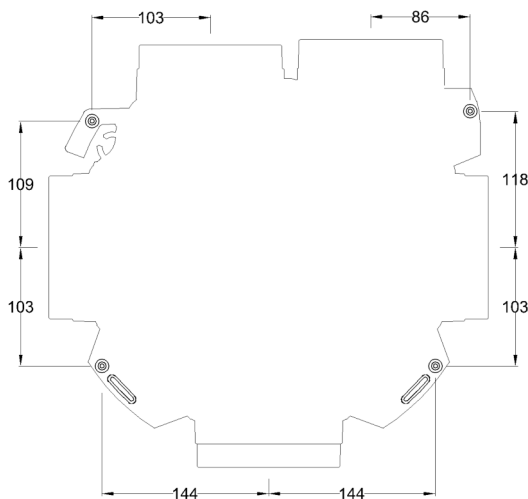
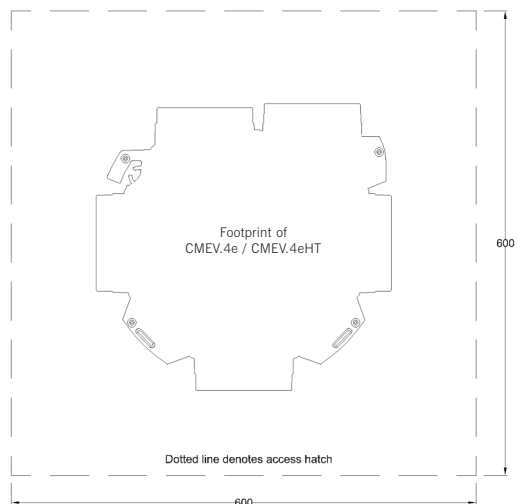

Figure 4 - Access for Maintenance



## 2.4 Ducting Guidelines

- 2.4.1 Please refer to design drawings for proposed ducting layout.
- 2.4.2 5 x 125mm nominal diameter spigots are provided for connection to ducting. Ductwork should be securely connected to spigots. Failure to do this will cause unnecessary air leakage and impair performance.
- 2.4.3 If applicable, Fire dampers **MUST BE FITTED** in accordance with Part B of the Building Regulations.
- 2.4.4 **Rigid Ducting** - Install using the least number of fittings to minimise resistance to air flow. Where possible, final connection to grilles and unit should be made with a flexible connection. Mechanically fix ducts using metal jubilee clips or heavy duty plastic cable ties and appropriate non-hardening sealant for air tightness.  
**WARNING: Do not use screws for connection and ensure jubilee clips are not over tightened.**
- 2.4.5 **Flexible Ducting** - Ensure ducting lengths are kept to a minimum and ducting is pulled taut so that it is smooth and straight. Where bends are necessary and where ducting is run in restricted areas, ensure the ducting is not crushed. Mechanically fix ducts using metal jubilee clips or heavy duty plastic cable ties and tape seal for air tightness.  
**WARNING: Should be in accordance with Building Regulations.**
- 2.4.6 Ensure any ducting outside of the thermal envelope is insulated in accordance with Building Regulations.
- 2.4.7 The exhaust port of the unit must terminate to external air and be protected by a suitable wall or roof terminal. Roof terminal to have a minimum equivalent free area of 10,000mm<sup>2</sup>.
- 2.4.8 Ensure unused spigots are capped off using the blanking caps provided.

## 2.5 Electrical

- 2.5.1 **WARNING: The appliance MUST be earthed. All wiring must conform to BS7671: IEE Wiring Regulations.**
- 2.5.2 **WARNING: The CMEV.4e / CMEV.4eHT units must be isolated from the mains supply before removing the fan motor assembly.**
- 2.5.3 **The installation must be carried out by a qualified Electrician.**
- 2.5.4 When supplied from a 6 amp lighting circuit no local fuse is required. If electricity is not supplied via the lighting circuit, a localised 3 amp fuse must be used (see wiring diagrams).
- 2.5.5 The CMEV.4e / CMEV.4eHT units are supplied with a pre-wired mains flexible cord – PVC sheathed, 5-core green/yellow, blue, brown, black & grey & 0.75mm<sup>2</sup>.  
**'If the supply cord is damaged, it must be replaced by a special cord/assembly available from the manufacturer or its service agent. The replacement must be carried out by a qualified Electrician in accordance with IEE or local regulations'.**
- 2.5.6 Depending on required wiring (see diagrams), a triple-pole or a double-pole switch having a minimum contact separation of 3.0mm must be used to provide isolation for the unit.
- 2.5.7 The recommended switches / sensors for use with either models are:
- For CMEV.4e, wire using either switch-live (lighting circuit) with/without external Greenwood Airvac sensor or via a Greenwood Airvac GS2 2-position switch with an external Greenwood Airvac sensor (see below for function details).
  - For CMEV.4eHT, wire using either switch-live (lighting circuit), via a Greenwood Airvac GS2 2-position switch with/without an external Greenwood Airvac sensor or via a Greenwood Airvac GS1 3-position switch (see below for function details).

**CMEV.4e / CMEV.4eHT**

GS2 Remote Switch Positions	Function
Trickle (I)	Fan running at trickle speed
Boost (II)	Fan running at med/boost speed

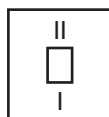

(See Wiring Diagrams on page 6).

**CMEV.4eHT only**

GS1 Remote Switch Positions	Function
Trickle (Centre position)	Fan running at trickle speed
Medium (I)	Fan running at medium speed
Boost (II)	Fan running at boost speed

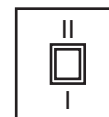

- 2.5.8 The fan speed control **must not** be mounted above or closer than 1m to the cooker where it could be affected by excessive heat or moisture.

## 2.6 Wiring Diagrams

### 2.6.1 Two speed control via light switch (CMEV.4e / CMEV.4eHT)

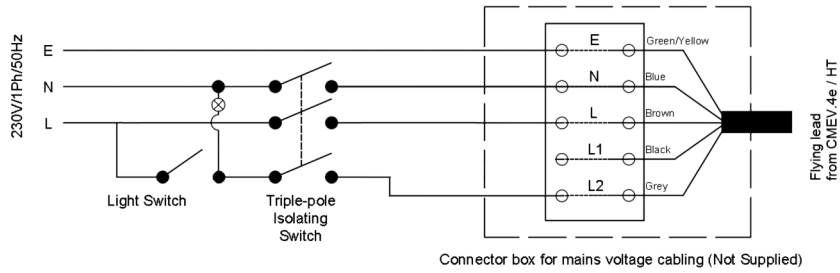

### 2.6.2 Two speed control via GS2 switch (CMEV.4eHT only)

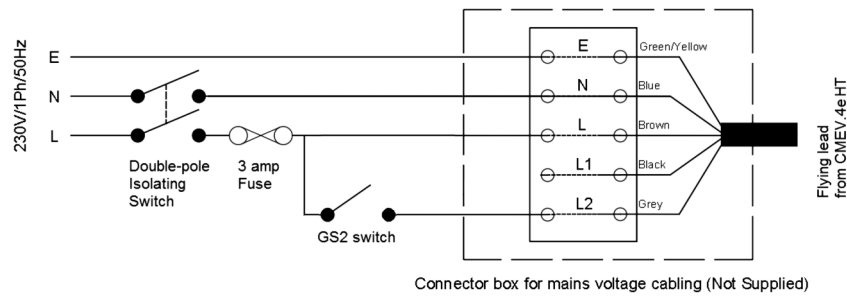

### 2.6.3 Three speed control via light switch for trickle & boost speeds and medium speed activation via remote sensor (CMEV.4e only)

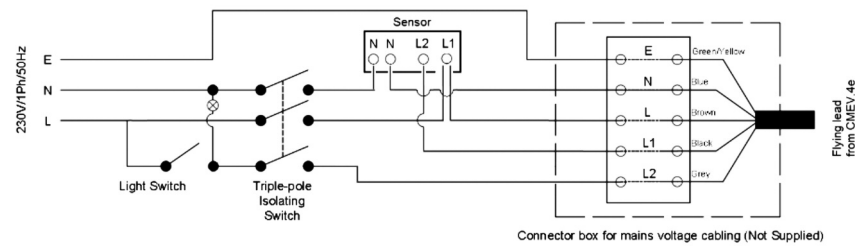

### 2.6.4 Three speed control via GS2 switch for trickle & boost speeds and medium speed activation via remote sensor (CMEV.4e / CMEV.4eHT)

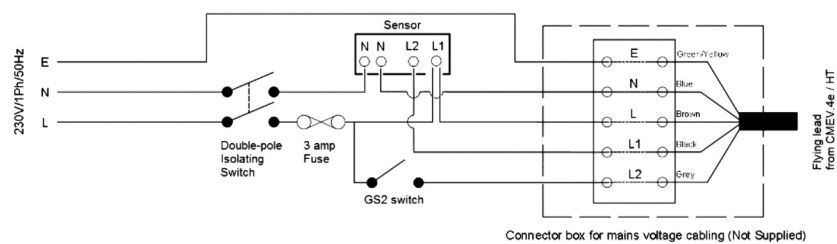

### 2.6.5 Three speed control via GS1 switch (CMEV.4eHT only)

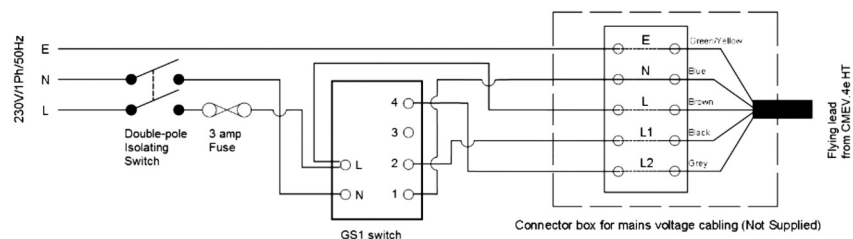

## 2.7 BMS Connectivity – CMEV.4eHT Only

2.7.1 The CMEV.4eHT unit can be connected to a BMS system that can provide a variable 0-10 Volt output that will be used to control the fan operating speed, as shown within table 1.1 below:

Voltage	Speed Control
0V – 3.2V	Trickle
3.3V – 6.4V	Medium
6.5V – 10V	Boost

Table 1.1

### 2.7.2 Removal of Fan Motor Assembly (See Figure 5)

**WARNING: The CMEV.4eHT unit must be isolated from the mains supply before removing the fan motor assembly.**

- 1) Remove external locking screw (1).  
**CAUTION; Fan motor assembly is free to move after the next operation – in ceiling installations please ensure the fan is manually supported during the following steps.**
- 2) Rotate anti-clockwise, noting 'LINE INDICATOR' moving from the 'LOCKED' to 'UNLOCKED' position (See Figure 5a).
- 3) Fan motor assembly can now be lowered / lifted out of main fan housing.

### 2.7.3 Figure 5 – Removal of Fan Motor

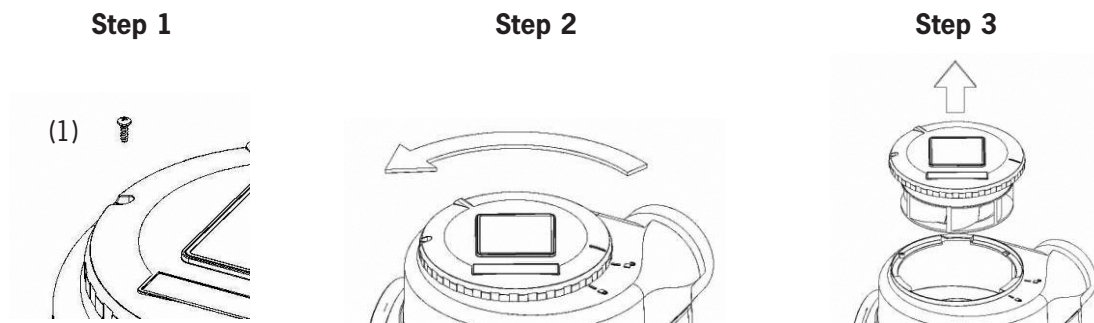
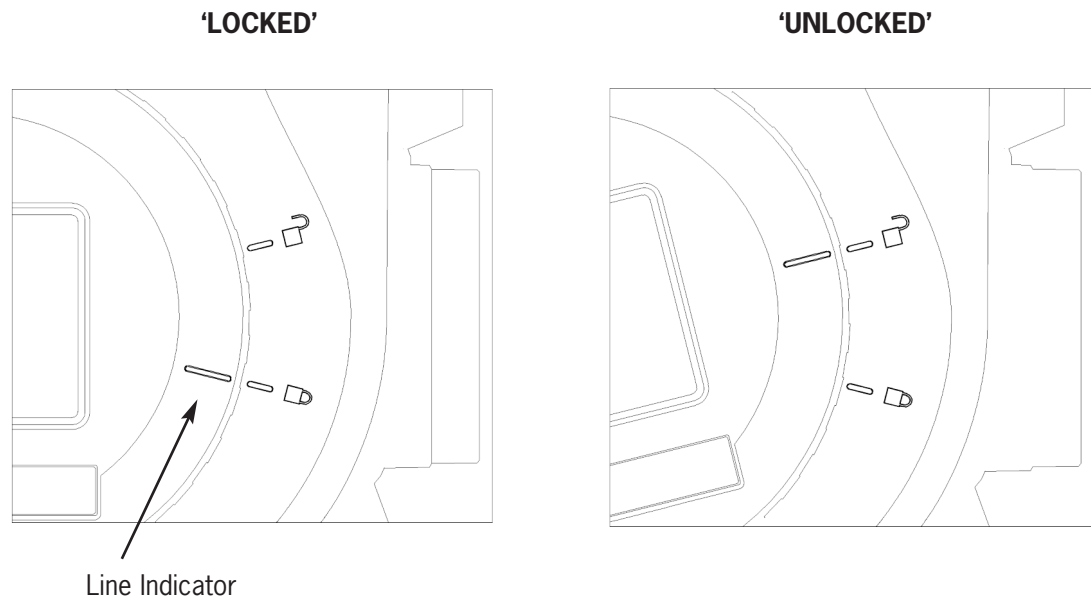

Figure 5a – 'LOCK' & 'UNLOCK' Positions





## 2.7.4 Wiring of the BMS to the CMEV.4eHT (See Figure 6)

- 1) Remove the three screws connecting the lid.
- 2) Carefully remove the lid to expose the PCB.
- 3) Carefully pierce through the 'closed' top hole within the lids cable grommet and pass through the BMS cable (not provided).
- 4) Remove the internal cable clamp in readiness for the BMS wiring.
- 5) Using a 5 or 6 core cable, sized between  $0.326\text{mm}^2$  -  $0.205\text{mm}^2$ , insert wires into the BMS terminal block on the PCB (as per table 1.2 below). Pin 2 is a volt free contact for additional sensors.
- 6) Secure the cable within the internal cable clamp provided.
- 7) Carefully realign the lid to the 'pot controls' and respective screw connections and secure with the three connecting screws.

2.7.5 Figure 6 – Connecting BMS Wiring

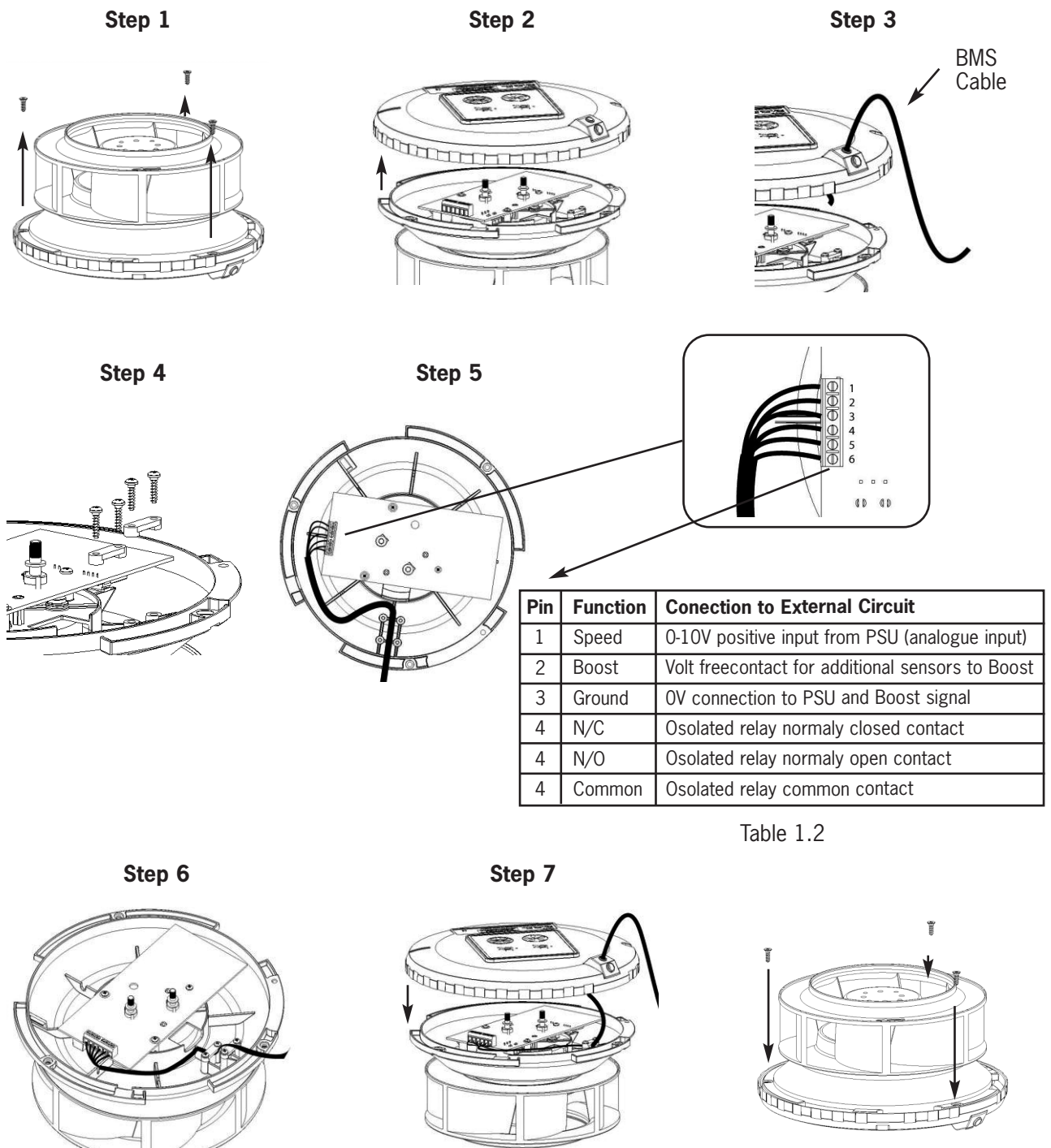

Table 1.2



## 2.7.6 Fan Motor Assembly Replacement (See Figure 7)

- 1) Realign the fan motor assembly 'LINE INDICATOR' with the 'UNLOCKED' symbol on main fan housing.
- 2) Ensure fan motor assembly has a positive fit, and push firmly into main fan housing. Rotate fan motor assembly until it stops. The 'LINE INDICATOR' should now be in line with the 'LOCKED' symbol (See Figure 7a).
- 3) Replace external locking screw (1).
- 4) Turn on mains supply and confirm correct operation.

### 2.7.7 Figure 7 – Replacement of Fan Motor

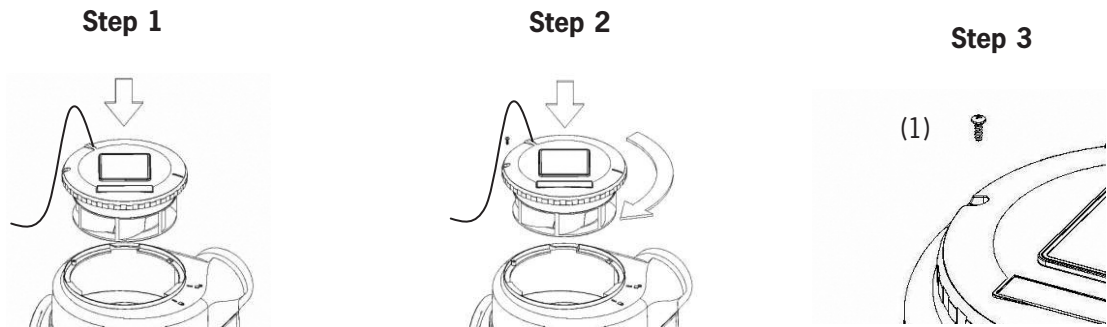
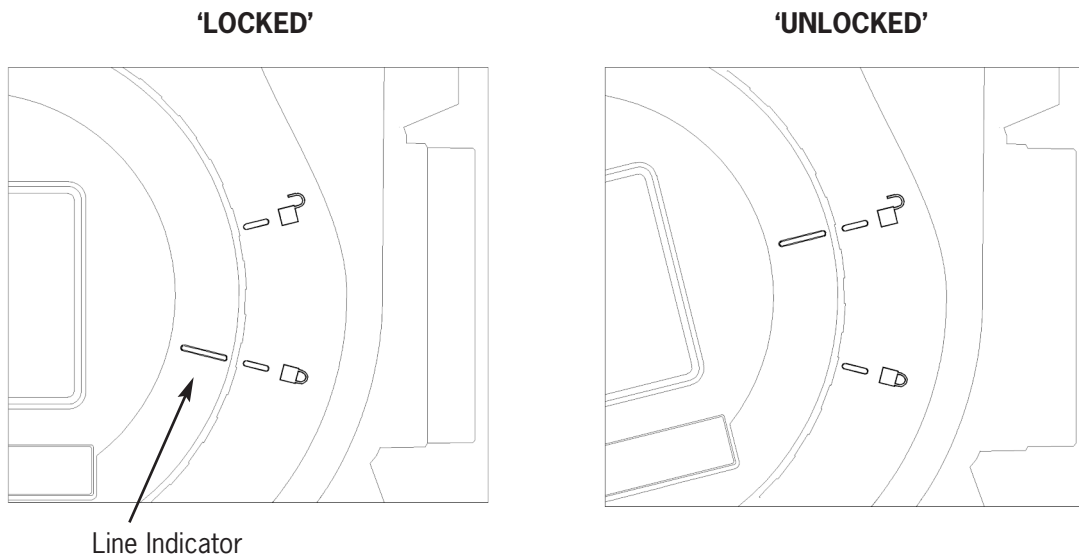

Figure 7a – 'LOCK' & 'UNLOCK' Positions



## 2.8 On Site Commissioning

2.8.1 This section covers set up, configuration of the unit on installation and altering pre-set factory settings. Dependant on which model has been installed the following set up and configuration will apply.

### 2.8.2 CMEV.4e / CMEV.4eHT Models

- Once the wiring connections have been checked, switch the mains supply on and check that the system is operating correctly, as per installed wiring / switch / sensor control configurations (see respective per wiring diagram).
- Performance levels to be verified at the extract valves (See section 2.8.3) using an appropriate method such as a rotating vane anemometer and air cone kit. Record airflow rates for room extract valves for trickle and boost speeds on the front page of this installer guide.
- Refer to performance graph for relevant model for airflow characteristics (See section 2.9).

### 2.8.3 Valve Set-up

- Switch the unit to the highest operating position.
- Close external windows and doors.
- With the system operating in boost mode, proceed to open the valves to their maximum.
- Measure the total air volume at the valves.
- Regulate the valves to the required flow per room.
- Switch the unit to trickle speed to confirm desired extract rate is achieved. It should normally not be necessary to adjust the extract valves further.

### 2.8.4 CMEV.4e / CMEV.4eHT – Fine Tuning

Minor adjustments may be required depending on overall ductwork length.

Fine-tuning of the motor speeds can be achieved by using the 'turn pots' on the fan casing to ensure optimum efficiency (See Figure 8). Record airflow rates for room extract valves and also the 'pot' settings for trickle and boost speeds on the front page of this installer guide.

### 2.8.5 Figure 8 - 'Speed Pot' Setting Adjustment Panel

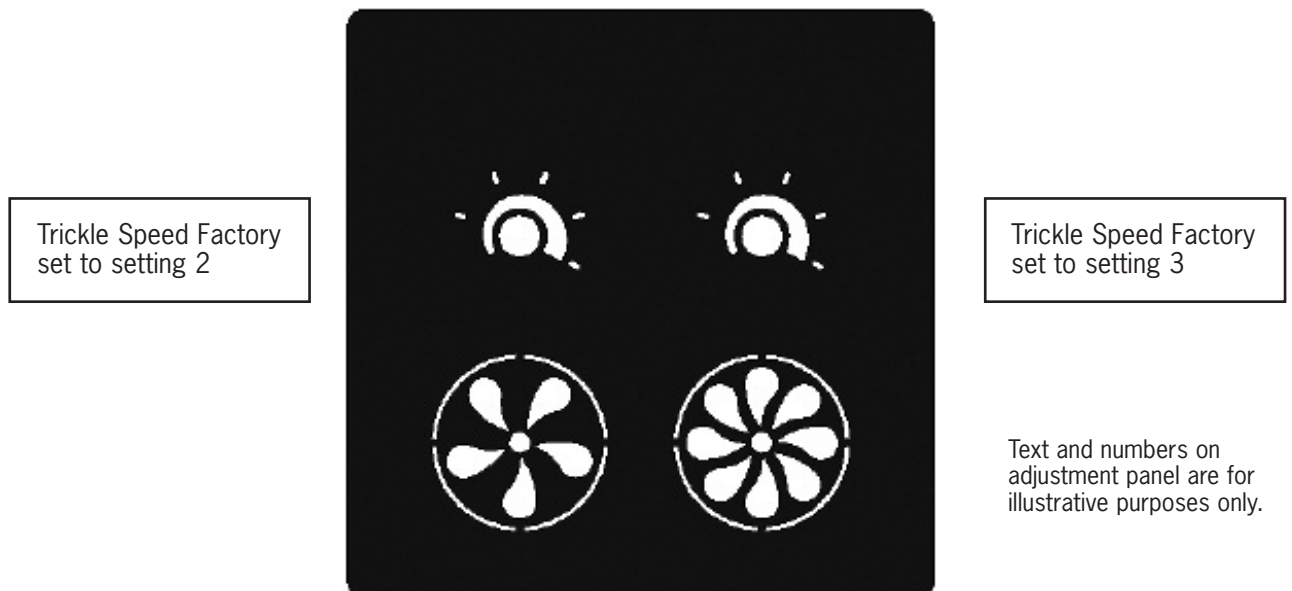

Note; Fan performance can be adjusted between these set points for further fine tuning, as the motor is 100% variable in range.

### 2.8.6 CMEV.4eHT Only – Greenwood TimerSMART™ and Greenwood HumidiSMART™

The CMEV.4eHT features a fully automatic integral timer function and humidity function which monitors the homeowners' environment. Neither of these functions require set-up.

### 2.8.7 CMEV.4e / CMEV.4eHT – Factory Settings

Factory settings suitable for two bedroom apartments up to 100m<sup>2</sup> floor area, with a Kitchen plus 2 Wet Rooms (such as Bathroom, Utility Room, Shower Room, Ensuite, WC).

- 2.8.8 Use 'turn pots' to achieve the desired motor speed at both speeds. Medium speed represents the mid speed between the two settings. For example, if the trickle speed 'pot' is set to 20% of full motor speed and the boost speed 'pot' is set at 60%, Medium speed will automatically be 40%.

## 2.9 Performance Graphs

### 2.9.1 Airflow Characteristics for CMEV.4e / CMEV.4eHT Models

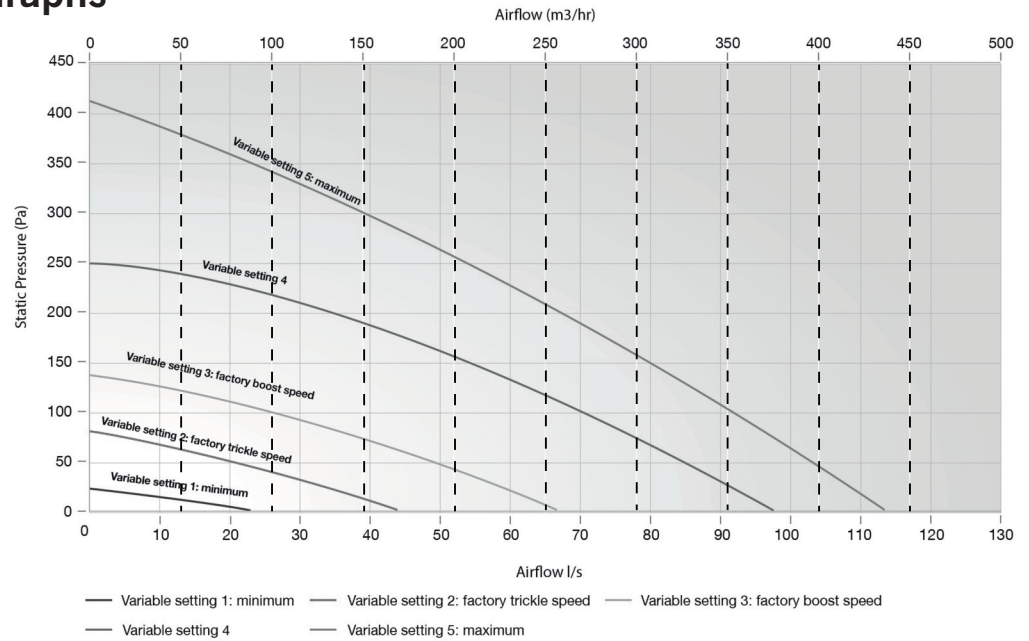

## 3.0 Declaration of Performance

### Declaration of Performance Residential Ventilation Unit Greenwood Centair CMEV.4e / HT

Supplier Name or Trade Mark	Greenwood Airvac			Greenwood Airvac		
Supplier Model Identifier and Options Installed	Central Demand Control (with 1 sensor)			Local Demand Control (with 2 or more sensors)		
SEC in [kWh/(m²a)] specific energy consumption (Cold, Average, Warm)	-41.6	-20.6	-8.6	-54.6	-27.5	-12.0
SEC Class (Cold, Average, Warm)	A	D	F	A+	B	E
Declared Typology	Unidirectional			Unidirectional		
Type of Motor Drive Installed	Variable Speed			Variable Speed		
Type of Heat Recovery	None			None		
Heat Recovery Efficiency	n/a			n/a		
Maximum Flow Rate in (m³/h) / (l/s)	352 / 98			352 / 98		
Electric Power Input at Maximum Flow Rate (W)	36			36		
Sound Power Level (L <sub>WA</sub> ) in dB(A)	51			51		
Reference Flow Rate in (m³/h) / l/s)	245 / 68			245 / 68		
Reference Pressure Difference	50			50		
SPI in [W/(m³/h)]	0.06			0.06		
Control Factor and Typology	.85			.65		
Declared Maximum Internal and External Leakage (%)	Internal: n/a External: n/a			Internal: n/a External: n/a		
Position and Description of Visual Filter Warning	n/a			n/a		
Internet Address for Preassembly / Disassembly Instructions	www.greenwood.co.uk			www.greenwood.co.uk		
AEC (kWh electricity/a) for Each Climate (Cold, Average, Warm)	0.5	0.5	0.5	0.3	0.3	0.3
AHS (kWh electricity/a) for Each Climate (Cold, Average, Warm)	42.9	21.9	9.9	55.4	28.3	12.8

## 4.0 The Guarantee Period

- 4.1.1 This Greenwood product (**CMEV.4e / CMEV.4eHT**) has a 2 Year Guarantee.
- 4.1.2 This does not affect your statutory rights.
- 4.1.3 Full details available on request from +44 (0) 1276 408404 or [www.greenwood.co.uk](http://www.greenwood.co.uk) / [info@greenwood.co.uk](mailto:info@greenwood.co.uk)

All information is believed correct at time of going to press. E&OE.

All goods are sold according to Zehnder Group UK Ltd's Standard Conditions of Sale which are available on request. All dimensions referred to are in millimetres unless otherwise shown.

Zehnder Group UK Ltd reserves the right to change specifications and prices without prior notice.  
© Copyright Zehnder Group UK Ltd 2018.

### Zehnder Group UK Limited

Watchmoor Point, Camberley,  
Surrey, GU15 3AD

Customer Services: +44 (0) 1276 408404  
Technical Services: +44 (0) 1276 408402  
Email: [info@greenwood.co.uk](mailto:info@greenwood.co.uk)  
Web: [www.greenwood.co.uk](http://www.greenwood.co.uk)

