

Commissioning Set 4218 CS

4218 GF DRV + HV2740 Orifice Plate

flanged version, Screw-down model, with Test

Points Data sheet for 4218 CS, Issue 0920

☑ 4218 GF with test points

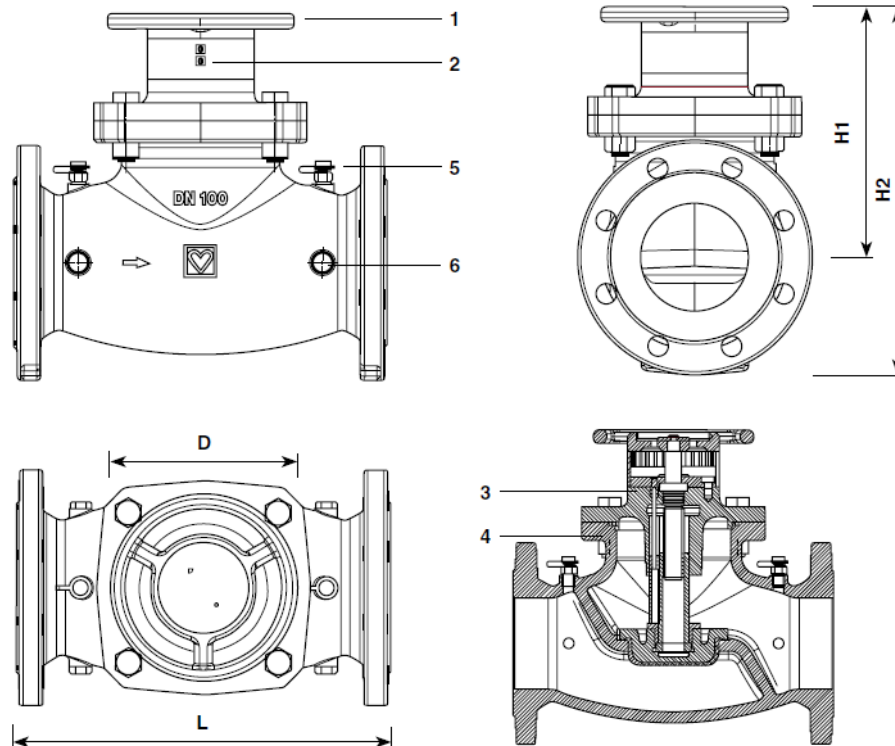

1. Hand wheel
2. Digital display of presetting
3. Upper part made of grey cast iron GJL 250
4. Body made of grey cast iron GJL 250
5. Test Points 1/4
6. Plugs 1/4

Flange dimension according to EN 1092-2

Order number	DN	PN	L	H1	H2	D	kvs	kg
1 4218 80	50	16	230	169	252	150	49	16,8
1 4218 81	65	16	290	186	280	150	75	23,6
1 4218 82	80	16	310	208	308	175	110	30
1 4218 83	100	16	350	235	345	175	165	38
1 4218 84	125	16	400	260	385	265	241	63
1 4218 85	150	16	480	308	451	265	372	88
1 4218 86	200	16	600	449	619	450	704	161
1 4218 87	250	16	730	503	705	450	812	256
1 4218 88	300	16	852	562	842	450	1383	383

☑ Models

STRÖMAX-GF-circuit regulating valve with test points, DN 50 - 300 Screw-down model, grey cast iron body GJL 250 acc. EN 1561, flange acc. EN 1092, PN 16, blue enamel coating. Upper part grey cast iron GJL 250, with non-rising spindle, spindle seal by means of triple O-Ring. Presetting step is shown on the digital display.

Transportation

Don't lift or carry the valve with the hand wheel!

The valve is pre-finished ex factory delivered. To prevent the possible impurities on the seat during the storing and transportation the valve is closed. In order to avoid any fouling during storing and transportation, the flange covering must be fitted.

Storing: Temperature -10° to + 50 °C, humidity max. 70%

Test points

Two test points 1 **0284** and presetting marker 1 **6517 05** are included. Test points position optional. This alignment allows the best access in all kind of installations and optimal connection of measuring devices.

Bore size

Pipe thread 1/4, for test points mounting

Field of application

For hydraulic balancing in heating or cooling systems for isolating of manifolds, risers, heat exchangers, heating and cooling systems.

Operational data

Maximum operating temperature 120 °C up to DN200 (DN250 & DN300 110 °C)

minimum operating temperature -10 °C

Maximum operating pressure 16 bar

Water purity in accordance with the ÖNORM H 5195 and VDI 2035 standards

Ethylene and propylene glycol can be mixed to a ratio of 25 - 50 vol. [%]

Ammonia contained in hemp can damage brass valve bodies, EPDM gaskets can be affected by Mineral oils lubricants and thus lead to failure of the EPDM seals. Please refer to manufacturers documentation when using ethylene glycol products for frost and corrosion protection.

Materials

Upper part	grey cast iron GJL 250 acc. EN 1561
Body	grey cast iron GJL 250 acc. EN 1562
Spindle	DN 50 - DN 100 brass, DN 125 - DN 300 stainless steel
Control spindle	Brass / stainless steel
Valve cone	grey cast iron GJL 250 acc. EN 1561/ EPDM coated
Counter	plastic material
O-Rings	EPDM

Coating

Base coat based on alkyd resins (resin primer) and contains lead and chromate anticorrosive.

Top coating with epoxy resin.

Solvent content is less than in the VOC plant regulation in 2002 accepted.

Gloss: matt Dry film thickness (DFT): ~ 100 microns

Constructional characteristics

Flow direction

Ensure that the flow direction is in accordance with the arrow shown on the valve body.

Mounting position

The non-rising valve spindle is mounted vertically to the valve axis and consequently offers optimum accessibility and easy valve handling in every position.

Seat seal

The spindle seal is equipped with an tripple O-Ring.

Tripple-O-Ring

The spindle seal is equipped with an elastic tripple O-Ring and is guaranteed to be impermeable and offer easy handling.

Seal between Upper Part and body (EPDM)

The permanently elastic soft seal provides constant temperature. It is corrosion-resistant and allows minor closing pressure.

☑ **Differential pressure measurement**

The Strömax GF Circuit regulating valve is equipped with two test points: so it is possible to measure the differential pressure by use of the proper measuring devices and to determine the flow rate accordingly.

☑ **Mass flow rate tolerance**

The maximum deviation of mass flow rate to characteristic of circuit regulating valves according to VDI-guidelines.

☑ **Pre-adjustment**

The valve will be delivered in closed position. The pre- setting permits the maximum possible stroke. The handwheel mechanics are so adjusted that with closed valve the digital display indicates 0.0.

☑ **Presetting and fixing**

Presetting

1. Desired presetting stage in accordance with data (Digital display on handwheel)
2. 1/10 of turn are the red numbers, full turn are the blue.
3. The presetting spindle is beneath the cover. The spindle can be adjusted with a scredriver 8 mm. To preset turn anti clockwise up to stop. The valve is now able to close and open back to the preset position. Replace the cover on the handwheel.
4. The pre-setting marker (1 6517 05) is fastened as a tag above the valve or pipe. The setting of the respective valve is marked by cutting or breaking off the teeth at the figures for full and partial turns. This permits checking and/or restoration of the original pre-setting made on the occasion of system set-up after servicing without having to rely on documentation.

The setting of flowrate is achieved with a measuring device referring to the flow charts. Please see the operating instructions from the measuring device.

☑ **Digital display factory setting**

If the valve is closed valve 0.0 is displayed on the digital display. If you have to remove the complete handwheel (turning handle, numeric wheels, baseplate) it is important to do this as following instruction:

1. Set the complete upper part and fastening the three allen screws and the four hexagon screws.
2. Close the valve clockwise.
3. If you see 0.0 on the digital display it is correct.
4. After this you can assemble the handwheel.
5. Fixing the attachment bolt.
6. Now you can preset the valve.

☑ **Accessories**

- 1 **6517 05** Pre-setting marker
- 1 **8900 04** HERZ-Measuring computer for one-hand operation
- 1 **0276 00** Draining valve 3/8 with handle and swivelling hose connection
- 1 **0284 00** Test point adaptors

☑ **Spare Parts**

- 1 **0273 00** Screw plug 3/8
- 1 **0284 01** test points, blue
- 1 **0284 02** test points, red

HERZ Stainless Steel Orifice Plate PN16

Standard sheet for
HV2740 (0912)

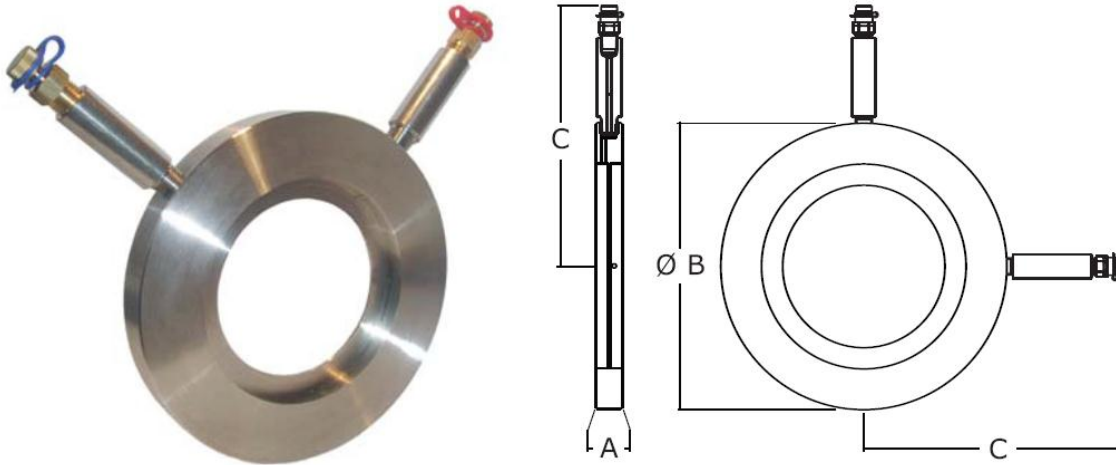

		Specification	
Component	Material	BS EN	ASTM
Body	Stainless Steel	10088 X5CrNi18-10	A276 304
Extension	Stainless Steel	10088 X5CrNi18-10	A276 304
Test Point	Brass	12164 CW602N	

Materials

Size	(mm)	65	80	100	125	150	200	250	300	350	400
A	mm	20	20	20	20	20	20	20	20	24	24
B	mm	129	144	164	194	220	275	331	386	446	498
C	mm	158	166	176	191	204	232	258	287	317	342
Weight	kg	1.9	2.2	2.7	3.2	3.8	5.5	7	10	12	14

Dimensions

Designed in accordance with BS1042

Flow Characteristics confirmed to BS7350

Flow measurement accuracy within $\pm 5\%$

Self sealing pressure test points

Outside diameter locates centrally within flange bolting to BS EN 1092-1

Pressure/Temperature Rating
16 bar @ -10 to 120°C

Specification



Herz Valves UK Ltd
Progress House
Moorfield Point
Moorfield Road
Guildford
Surrey
GU1 1RU

Tel 01483 502211
Fax 01483 502025

Sales@herzvalves.com

www.herzvalves.com

HERZ-Stainless steel orifice plate PN16

February 2013

Issue 1

Technical Data

The flow rate can be calculated using the K_{Vs} value and a measured signal.

$$K_V = \frac{Q}{\sqrt{\Delta P}} \quad K_{Vs} = \frac{Q}{\sqrt{\Delta P_s}}$$

where K_V & K_{Vs} = flow coefficient (m³/hr at 1 bar differential)

Q = flow rate (m³/hr)

ΔP = headloss attributable to orifice plate (bar)

ΔP_s = differential press across tappings (signal) (bar)

Flow Coefficient

Size	DN65	DN80	DN100	DN125	DN150	DN200
K_{Vs}	100.7	133.6	237.7	339	511	858

Size	DN250	DN300
K_{Vs}	1235	1793

K_{Vs} Values

The pressure loss across the orifice plate can be determined by multiplying the signal by the pressure loss factor.

The pressure loss is always less than measured signal.

Pressure Loss

Size	DN65	DN80	DN100	DN125	DN150	DN200
Factor	0.40	0.40	0.35	0.35	0.35	0.35

Size	DN250	DN300
Factor	0.35	0.35

Pressure Loss Factors

Under the Pressure Equipment Directive (PED) these commissioning sets have been specified for Group 2 Liquids i.e. non-hazardous

Sizes DN50 to DN300 are classified as SEP

PED Categorisation

Herz Valves UK Ltd.

Progress House, Moorfield Point, Moorfield Road
Slyfield Ind Estate, Guildford, Surrey GU1 1RU

Tel: 01483 502211
Fax: 01483 502025

e-mail: sales@herzvalves.com
Website: www.herzvalves.com



HERZ-Commissioning Valve PN16

February 2013

Issue 1

Technical Data

Herz 2740 orifice plates can be installed in isolation or close coupled to a globe double regulating valve complying with BS 7350, of the same nominal diameter.

Regardless of installation there must always be a minimum of 5 pipe diameters of straight pipe, without intrusion, upstream of the orifice plate.

When used in isolation a minimum of 3 pipe diameters of straight pipe are required downstream of the orifice plate.

When close coupled to a Herz 4218 double regulating valve no straight pipe is required after the valve.

When used in conjunction with a butterfly double regulating valve, a spool piece equivalent to a minimum of 2 pipe diameters is required between the orifice plate and butterfly valve.

For more detailed instructions please refer to the Installation, Operation and Maintenance Instructions supplied with the orifice plate and valve.

Installation

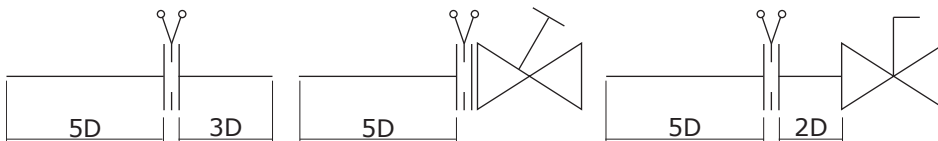

Once the required flow rate has been calculated, the size of the orifice plate can be determined based on the following:

The minimum signal at the design flow rate of 1 kPa.

For minimum pressure loss, a maximum signal of 4.7 kPa, which corresponds to the maximum differential pressure range of a fluorocarbon manometer.

Sizing

The pressure loss across the commissioning set is the combined loss attributable to the orifice plate and double regulating valve.

The double regulating valve shall not be used less than 25% open.

Pressure Loss

Herz Valves UK Ltd.

Progress House, Moorfield Point, Moorfield Road
Slyfield Ind Estate, Guildford, Surrey GU1 1RU

Tel: 01483 502211
Fax: 01483 502025

e-mail: sales@herzvalves.com
Website: www.herzvalves.com



HERZ-Double Regulating Valve PN16

February 2013

Issue 1

Technical Data

Position Open	DN65	DN80	DN100	DN125	DN150	DN200	DN250	DN300
3				60.7				
3.5		20.6		69.1				
4	15.4	22.9	40.9	77.5	69.3	137		
4.5	17.3	25.0	45.3	86.1	77.8	169	195	
5	19.5	27.1	49.7	94.8	88.3	201	216	
5.5	21.0	30.7	55.0	104	96.3	233	239	272
6	22.8	34.4	60.3	113	106	266	263	302
6.5	24.2	39.9	67.5	124	118	302	290	324
7	25.5	45.5	74.7	136	130	339	317	346
7.5	27.7	52.7	82.3	152	150	376	358	367
8	30.0	59.9	90.0	168	170	413	400	389
8.5	32.8	66.3	97.0	178	194	442	456	455
9	35.6	72.7	104	189	218	472	513	521
9.5	38.9	77.4	110	201	237	501	555	586
10	42.1	82.1	116	212	256	531	597	664
11	47.7	90.2	126	229	288	561	697	785
12	51.6	96.7	135	243	315	591	781	907
13	56.5	101.4	143	256	340	621	846	1009
14	60.8	107	151		355	649	928	1111
15	64.2		158		371	676	972	1238
16	66.9		165		390		1014	1365
17			169				1065	1447
18							1083	1529
22								1785

K_v Values

Herz Valves UK Ltd.

Progress House, Moorfield Point, Moorfield Road
Slyfield Ind Estate, Guildford, Surrey GU1 1RU

Tel: 01483 502211
Fax: 01483 502025

e-mail: sales@herzvalves.com
Website: www.herzvalves.com



HERZ - Flow data	Stainless Steel Orifice Plate
Art. HV 2740 - 07	Dim. DN65

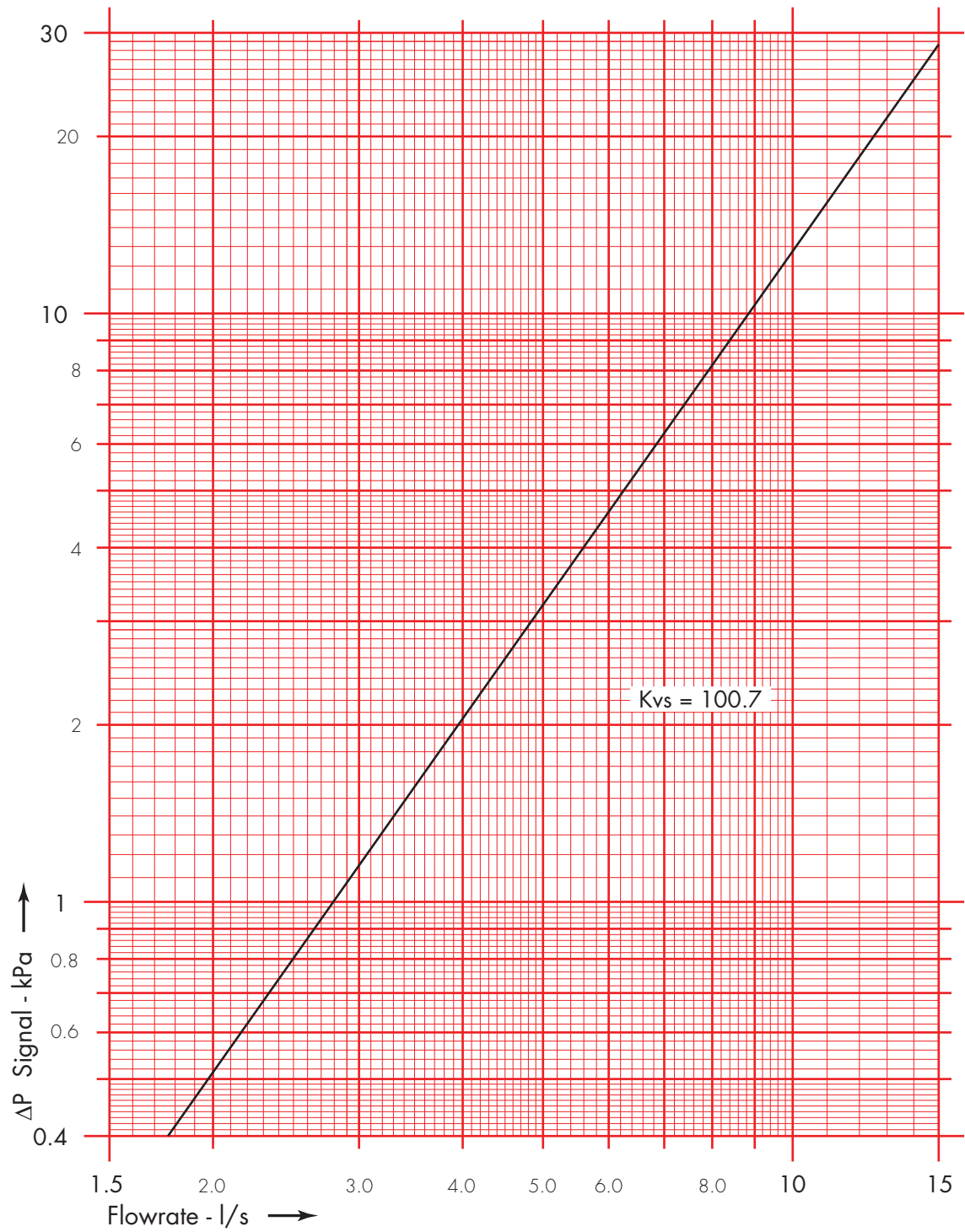

We reserve the right to make design modifications

HERZ Valves UK Ltd.
 Progress House, Moorfield Point, Moorfield Road
 Slyfield Ind Estate, Guildford, Surrey GU1 1RU
 Tel: 01483 502211 e-mail: sales@herzvalves.com
 Fax: 01483 502025 Website: www.herzvalves.com



HERZ - Flow data - pressure drop

Double Regulating Valve

Art. **4218** - 81

Dim. DN65

Position	4	5	6	7	8	9	10	12	14	16
Kv	15.4	19.5	22.8	25.5	30.0	35.6	42.1	51.6	60.8	66.9

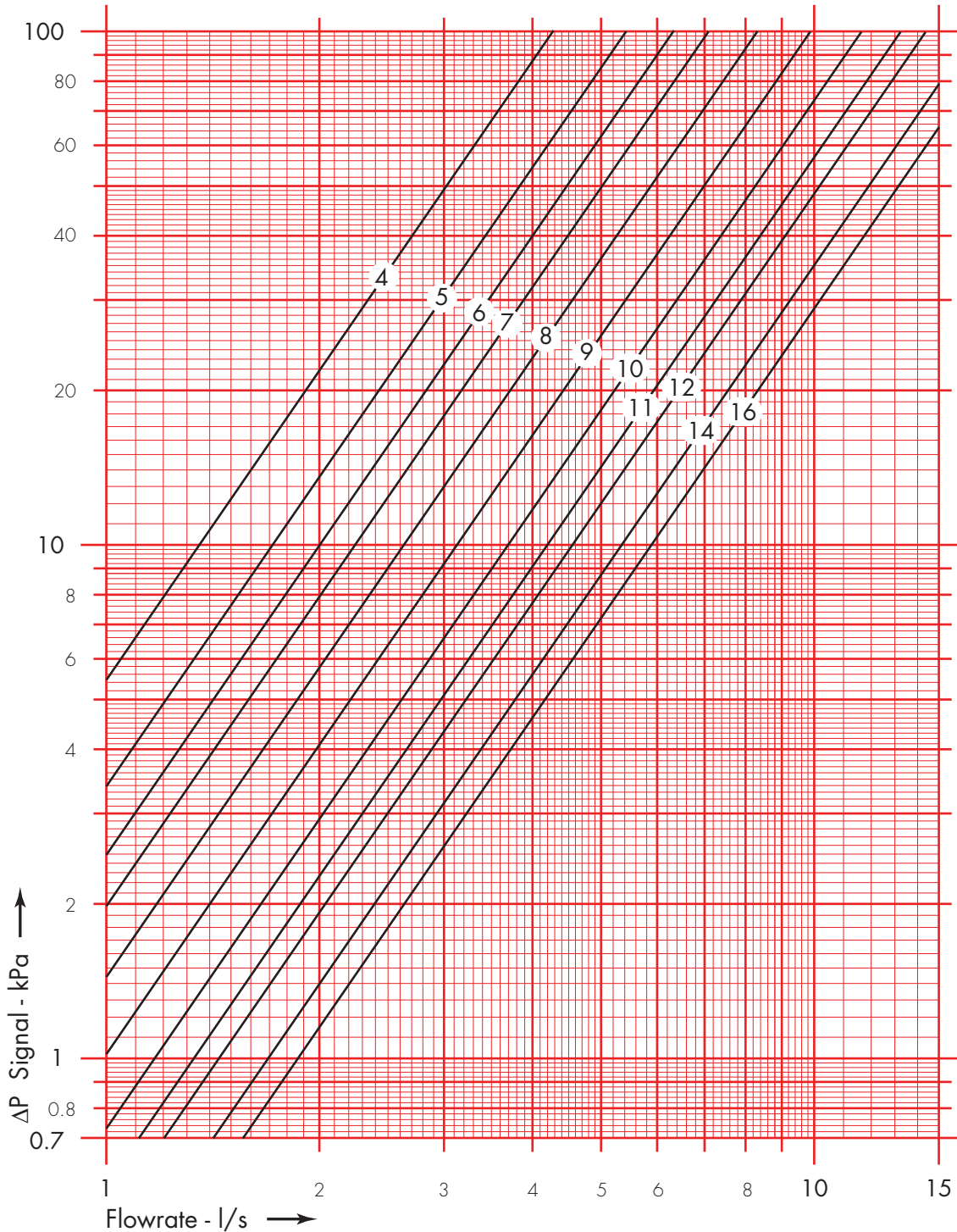

We reserve the right to make design modifications

HERZ Valves UK Ltd.

Progress House, Moorfield Point, Moorfield Road
Slyfield Ind Estate, Guildford, Surrey GU1 1RU

Tel: 01483 502211 e-mail: sales@herzvalves.com

Fax: 01483 502025 Website: www.herzvalves.com



HERZ - Flow data	Stainless Steel Orifice Plate
Art. HV 2740 - 08	Dim. DN80

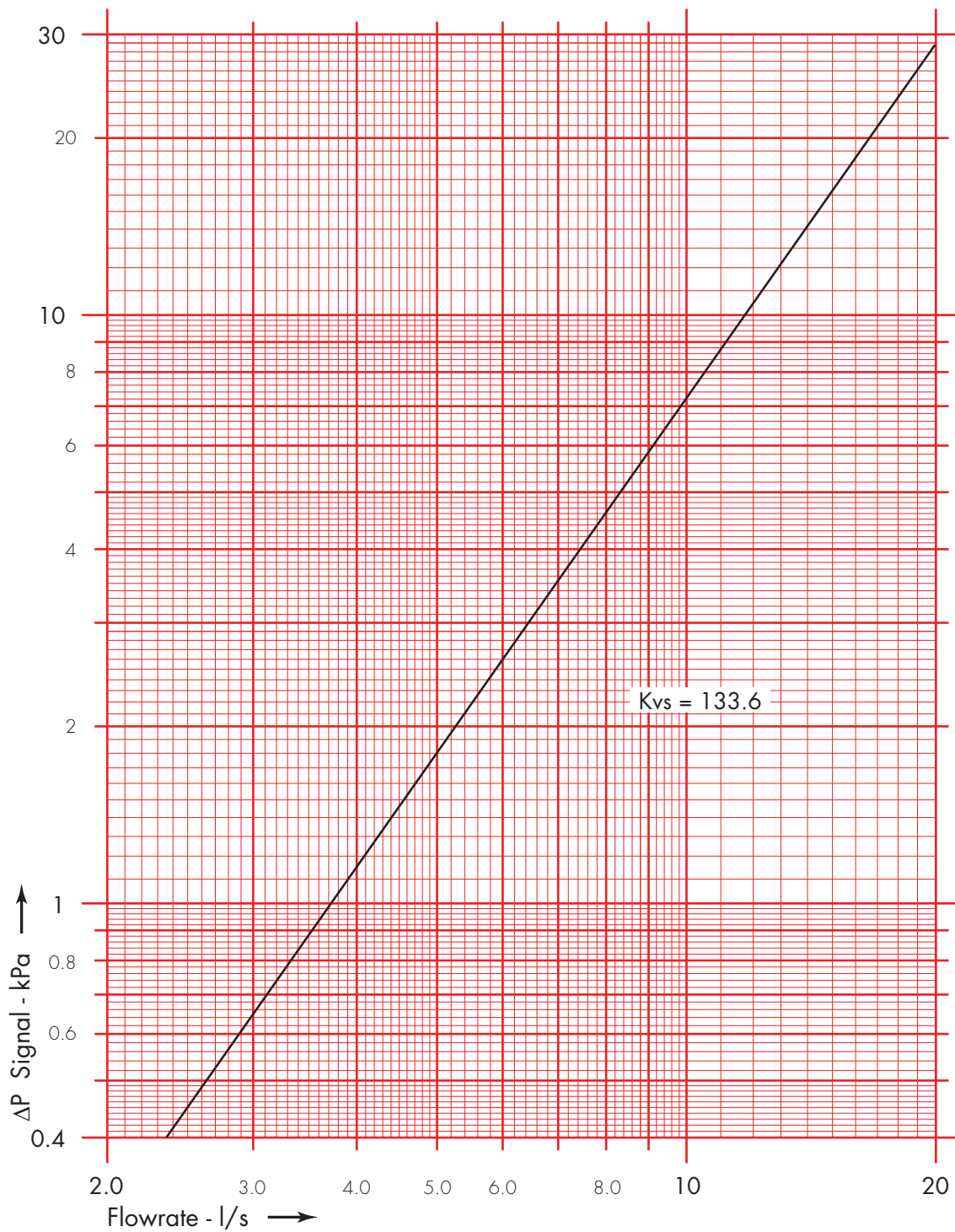

We reserve the right to make design modifications

HERZ Valves UK Ltd.
 Progress House, Moorfield Point, Moorfield Road
 Slyfield Ind Estate, Guildford, Surrey GU1 1RU
 Tel: 01483 502211 e-mail: sales@herzvalves.com
 Fax: 01483 502025 Website: www.herzvalves.com



HERZ - Flow data - pressure drop

Double Regulating Valve

Art. **4218** - 82

Dim. DN80

Position	3.5	4	5	6	7	8	9	10	12	14
Kv	20.6	22.9	27.1	34.4	45.5	59.9	72.7	82.1	96.7	107

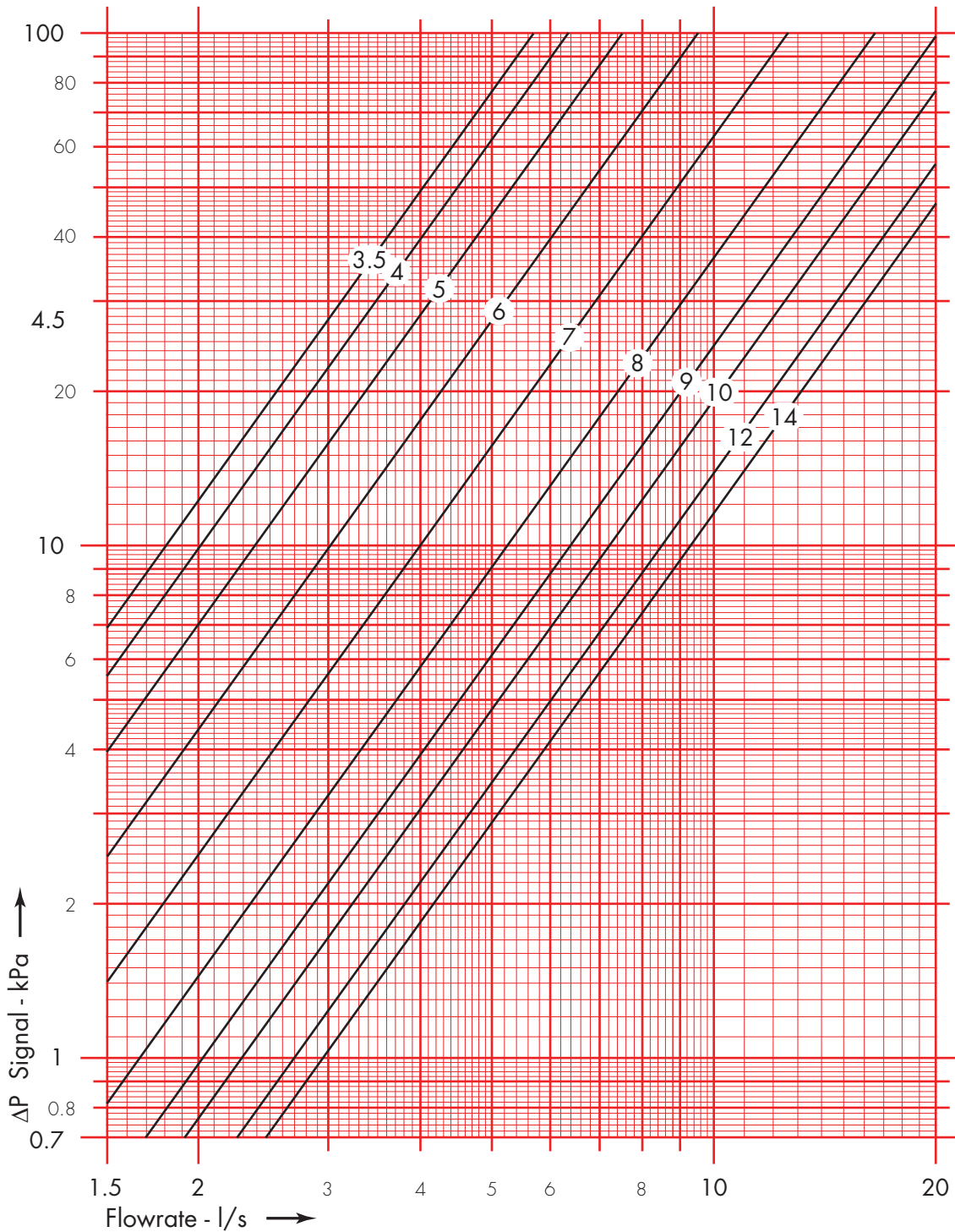

We reserve the right to make design modifications

HERZ Valves UK Ltd.

Progress House, Moorfield Point, Moorfield Road
Slyfield Ind Estate, Guildford, Surrey GU1 1RU

Tel: 01483 502211 e-mail: sales@herzvalves.com

Fax: 01483 502025 Website: www.herzvalves.com



HERZ - Flow data	Stainless Steel Orifice Plate
Art. HV 2740 - 09	Dim. DN100

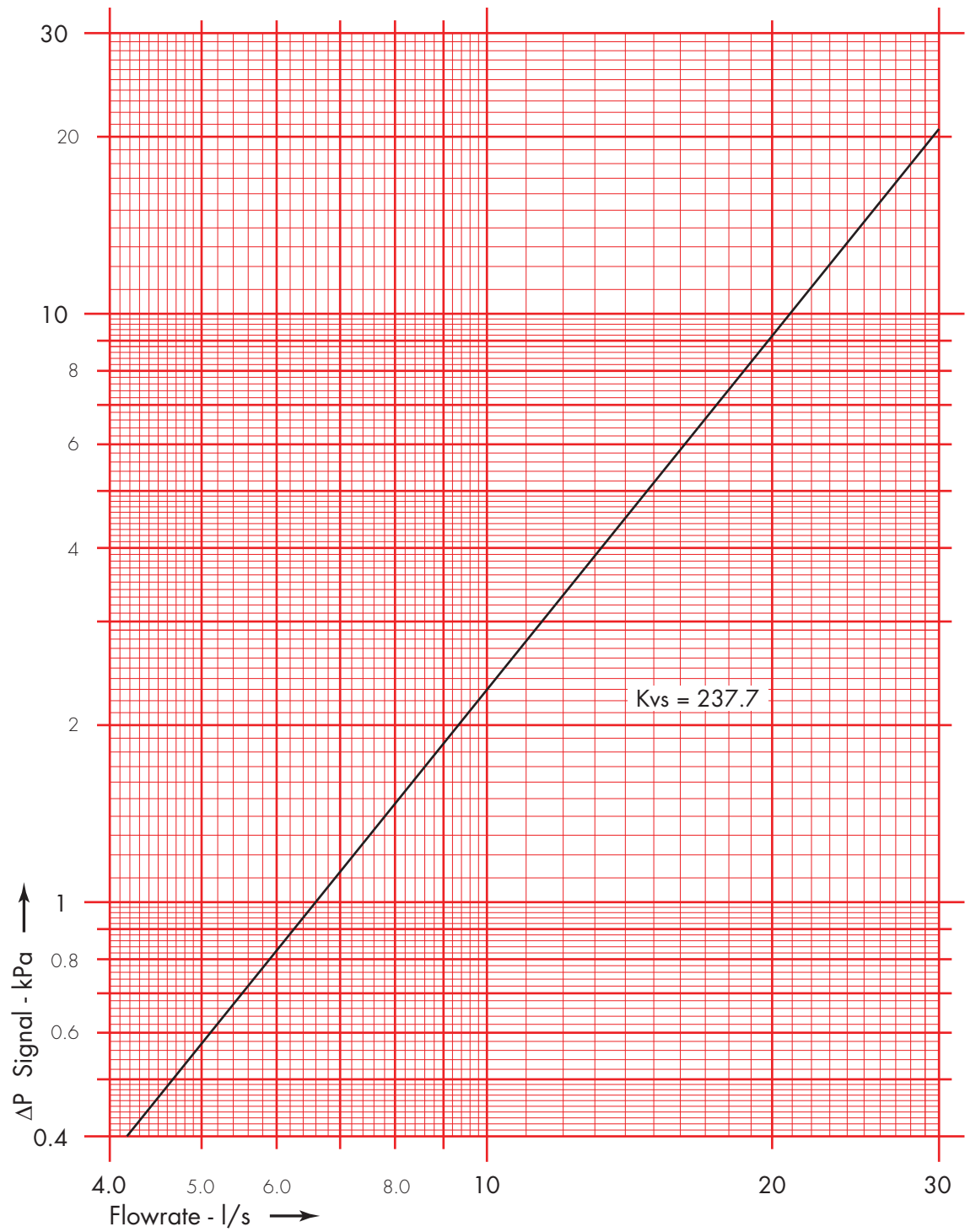

We reserve the right to make design modifications

HERZ Valves UK Ltd.
 Progress House, Moorfield Point, Moorfield Road
 Slyfield Ind Estate, Guildford, Surrey GU1 1RU
 Tel: 01483 502211 e-mail: sales@herzvalves.com
 Fax: 01483 502025 Website: www.herzvalves.com



HERZ - Flow data - pressure drop

Double Regulating Valve

Art. **4218** - 83

Dim. DN100

Position	4	5	6	7	8	9	10	12	14	17
Kv	40.9	49.7	60.3	74.7	90.0	104	116	135	151	169

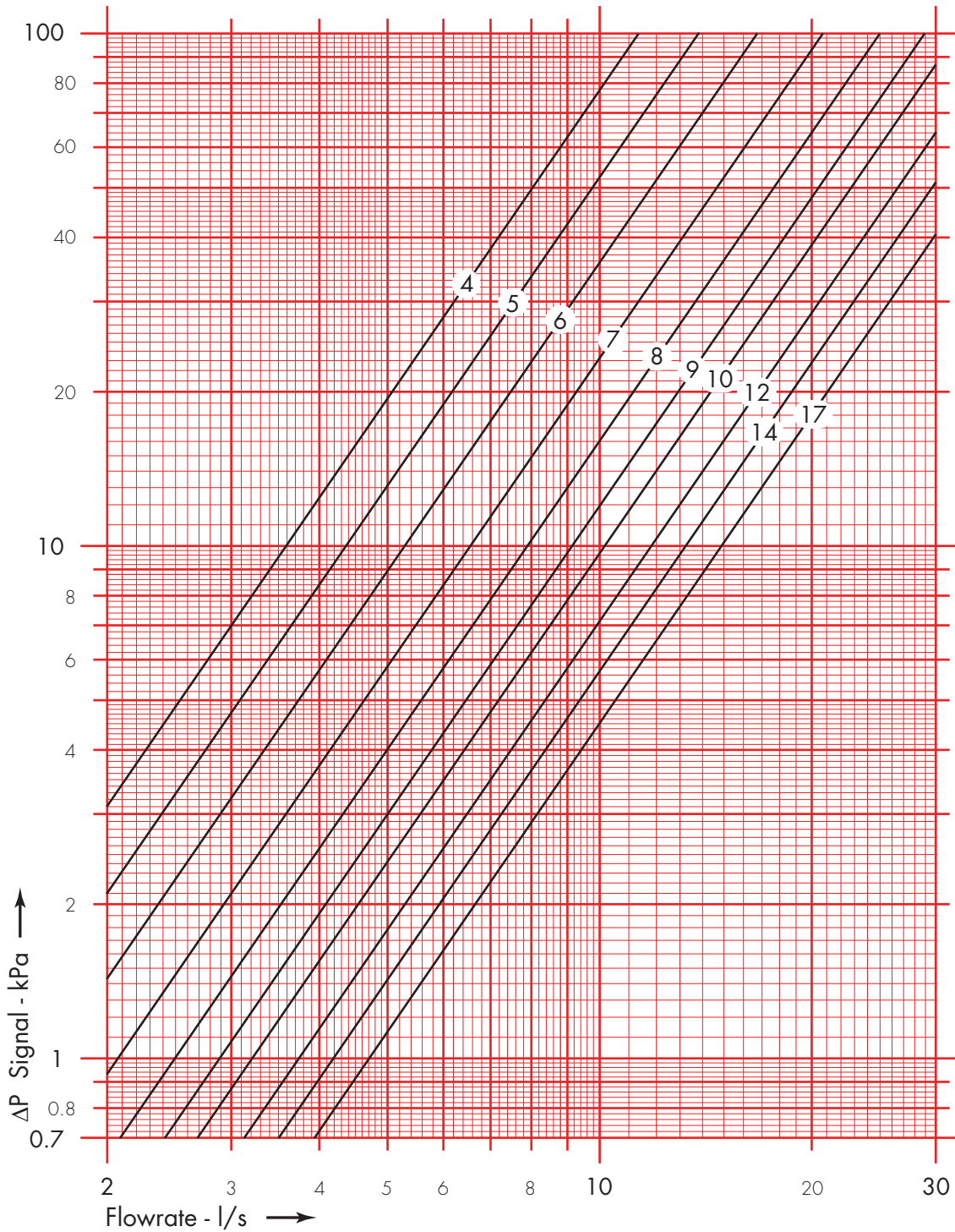

We reserve the right to make design modifications

HERZ Valves UK Ltd.

Progress House, Moorfield Point, Moorfield Road
Slyfield Ind Estate, Guildford, Surrey GU1 1RU

Tel: 01483 502211 e-mail: sales@herzvalves.com

Fax: 01483 502025 Website: www.herzvalves.com



HERZ - Flow data	Stainless Steel Orifice Plate
Art. HV 2740 - 10	Dim. DN125

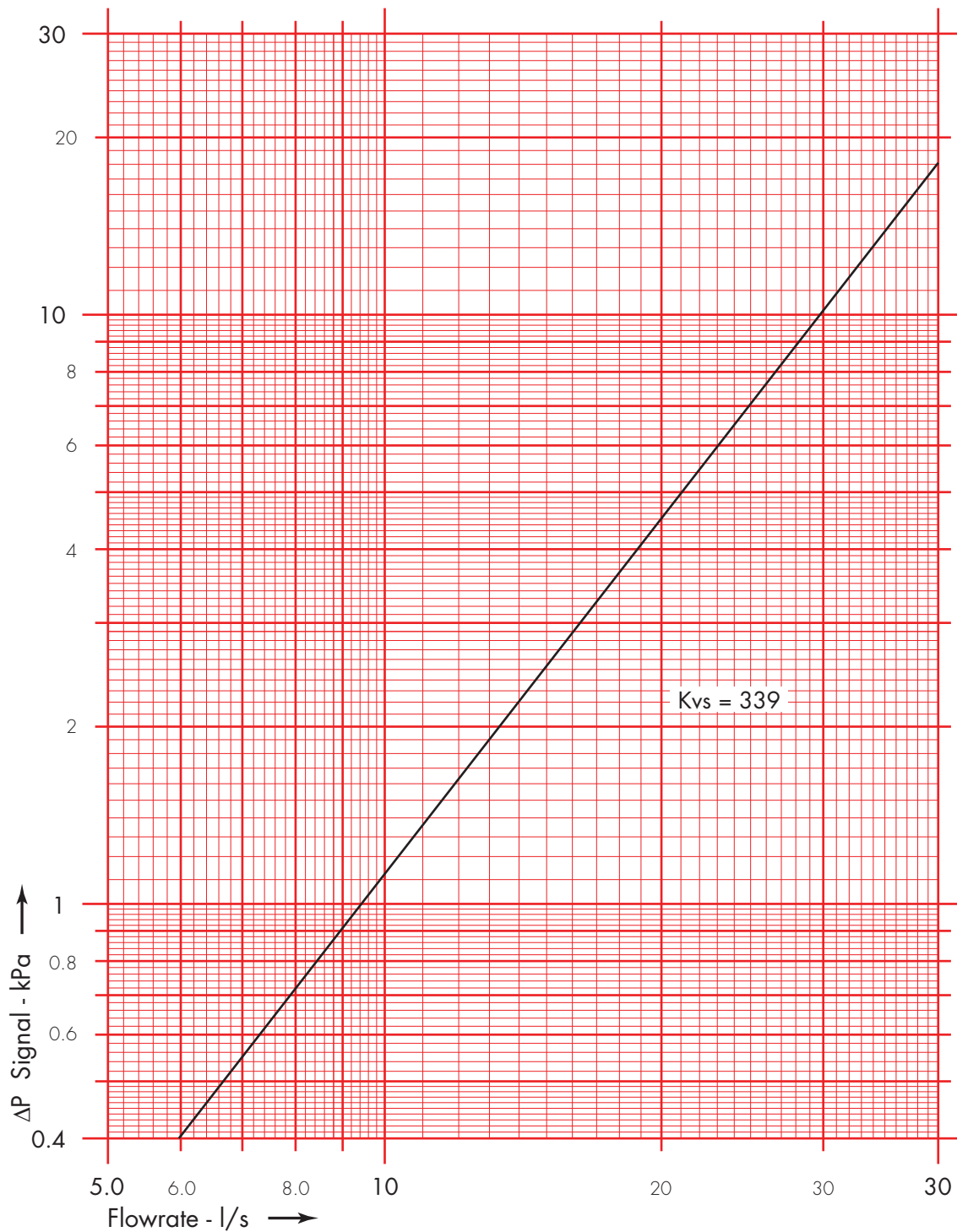

We reserve the right to make design modifications

HERZ Valves UK Ltd.

Progress House, Moorfield Point, Moorfield Road
Slyfield Ind Estate, Guildford, Surrey GU1 1RU

Tel: 01483 502211 e-mail: sales@herzvalves.com

Fax: 01483 502025 Website: www.herzvalves.com



HERZ - Flow data - pressure drop

Double Regulating Valve

Art. **4218** - 84

Dim. DN125

Position	3	4	5	6	7	8	9	10	13
Kv	60.7	77.5	94.8	113	136	168	189	212	256

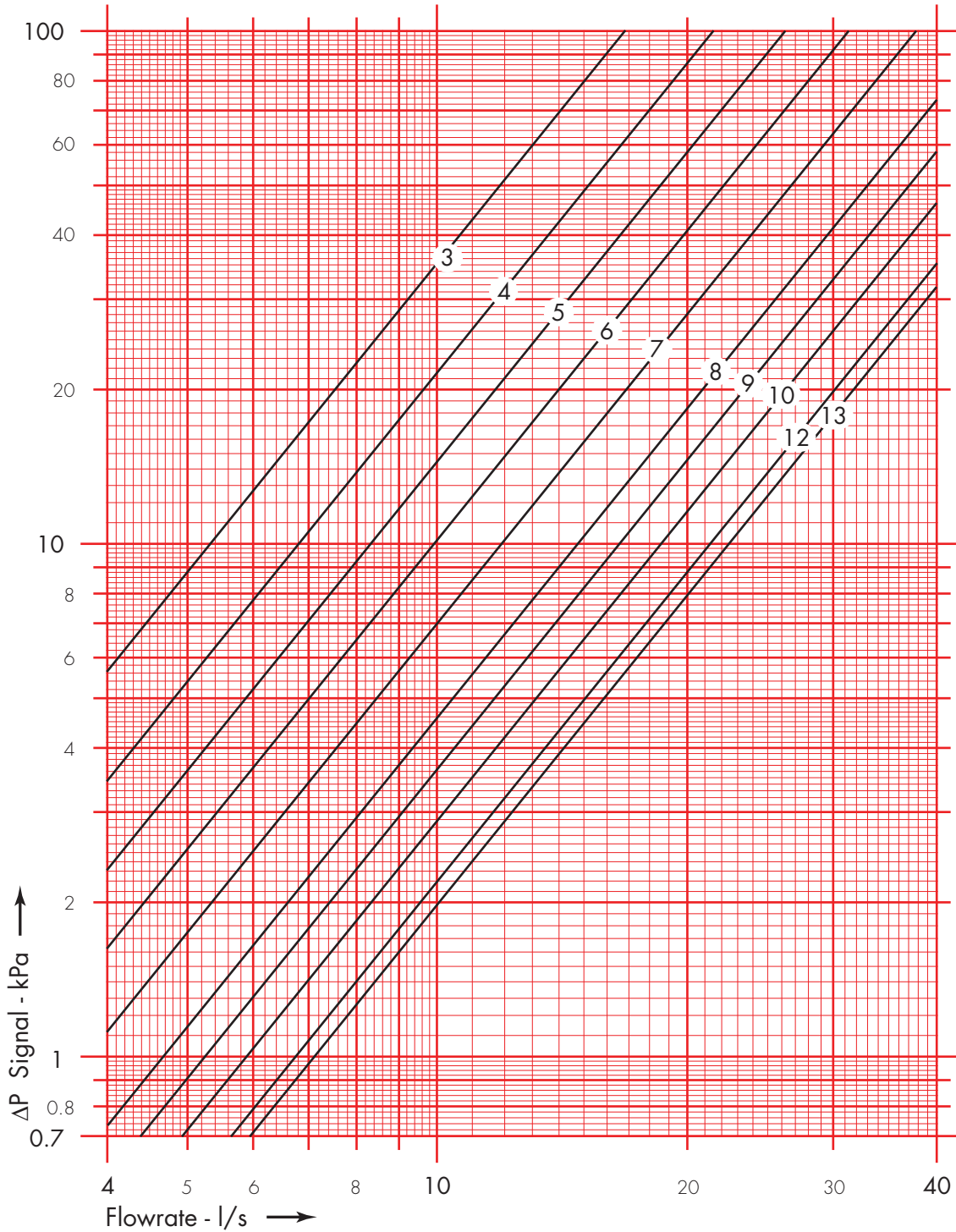

We reserve the right to make design modifications

HERZ Valves UK Ltd.

Progress House, Moorfield Point, Moorfield Road
Slyfield Ind Estate, Guildford, Surrey GU1 1RU

Tel: 01483 502211 e-mail: sales@herzvalves.com

Fax: 01483 502025 Website: www.herzvalves.com



HERZ - Flow data	Stainless Steel Orifice Plate
Art. HV 2740 - 11	Dim. DN150

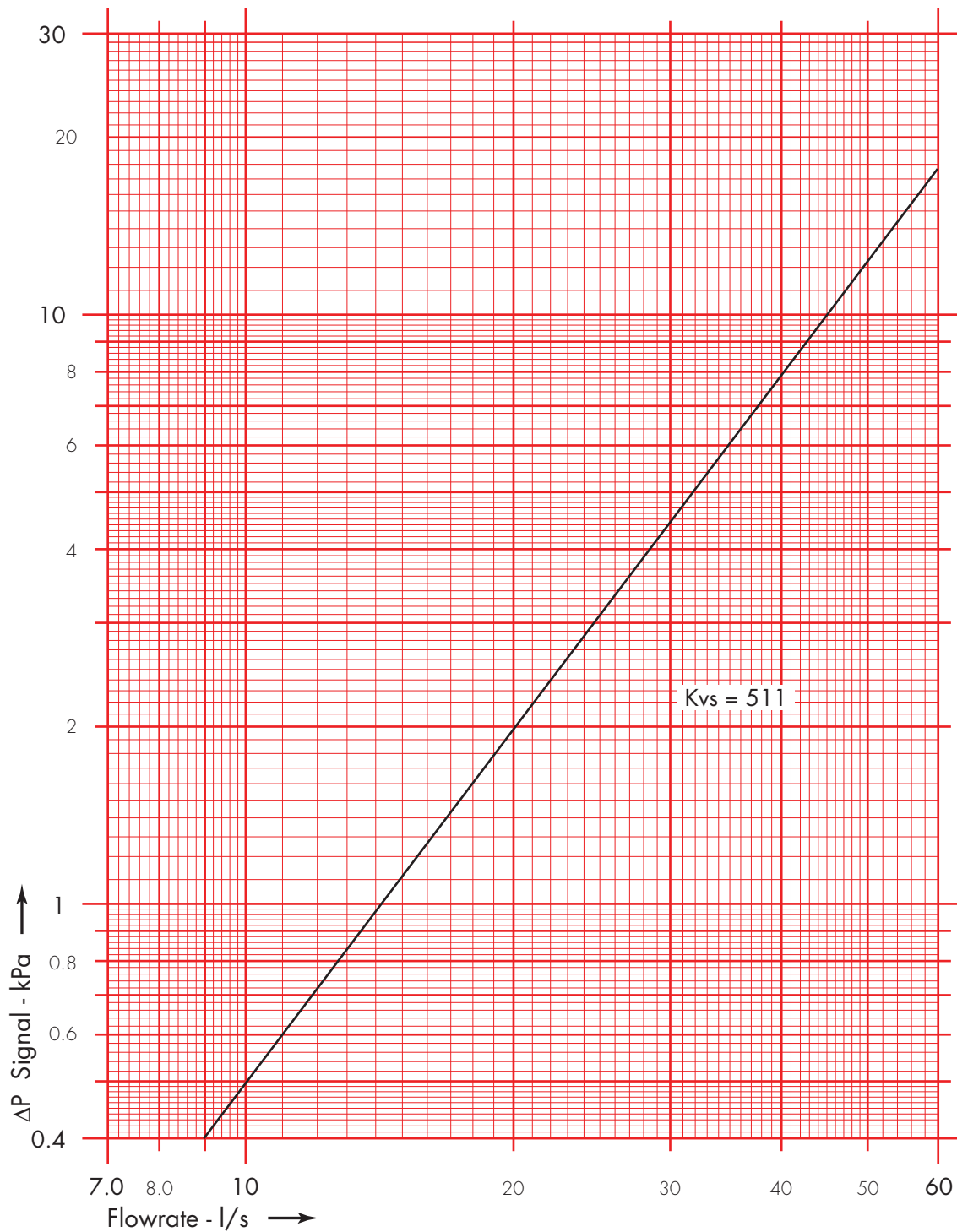

We reserve the right to make design modifications

HERZ Valves UK Ltd.

Progress House, Moorfield Point, Moorfield Road
Slyfield Ind Estate, Guildford, Surrey GU1 1RU

Tel: 01483 502211 e-mail: sales@herzvalves.com

Fax: 01483 502025 Website: www.herzvalves.com



HERZ - Flow data - pressure drop

Double Regulating Valve

Art. **4218** - 85

Dim. DN150

Position	4	5	6	7	8	9	10	12	14	16
Kv	69.3	88.3	106	130	170	218	256	315	355	390

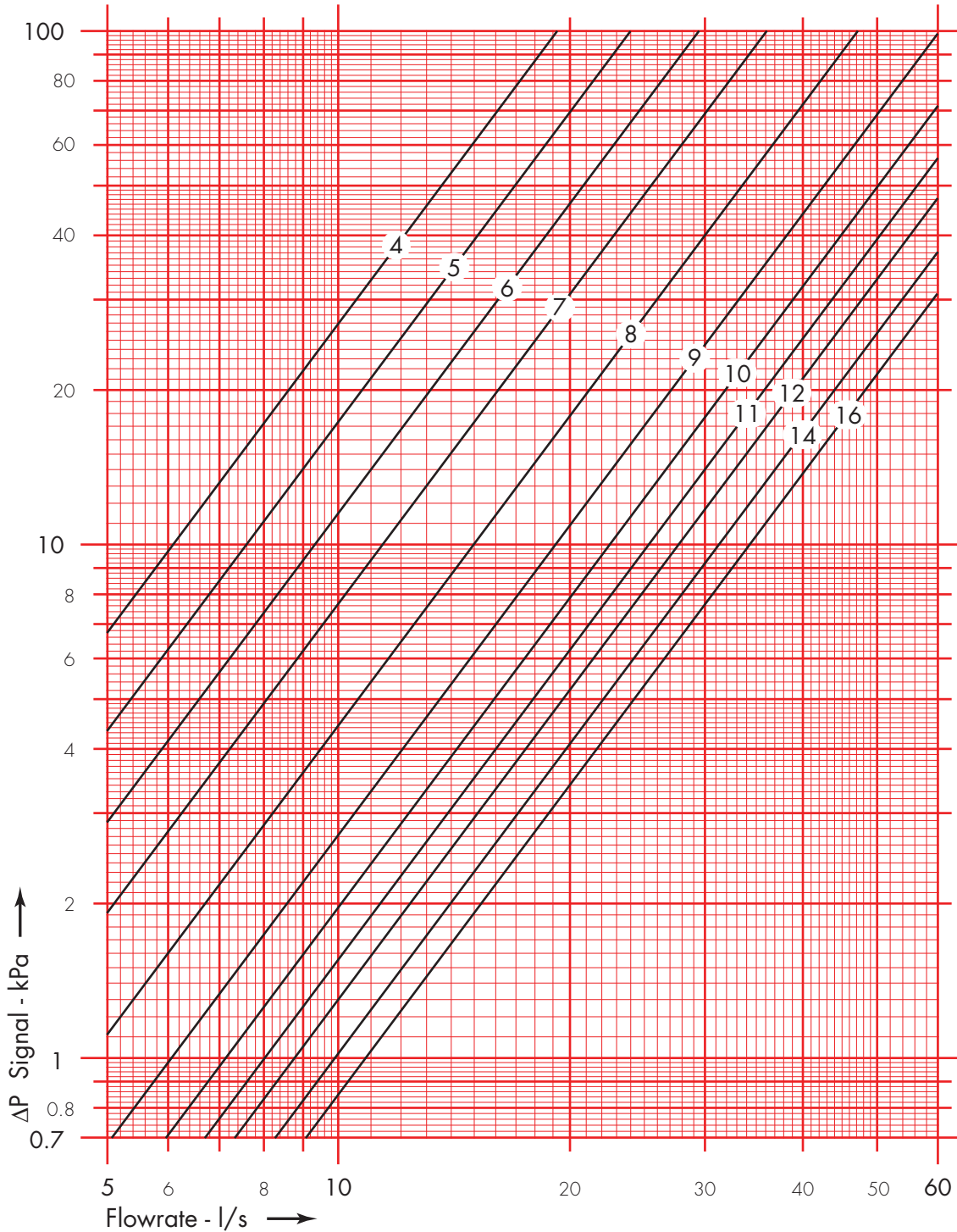

We reserve the right to make design modifications

HERZ Valves UK Ltd.

Progress House, Moorfield Point, Moorfield Road
Slyfield Ind Estate, Guildford, Surrey GU1 1RU

Tel: 01483 502211 e-mail: sales@herzvalves.com

Fax: 01483 502025 Website: www.herzvalves.com



HERZ - Flow data	Stainless Steel Orifice Plate
Art. HV 2740 - 12	Dim. DN200

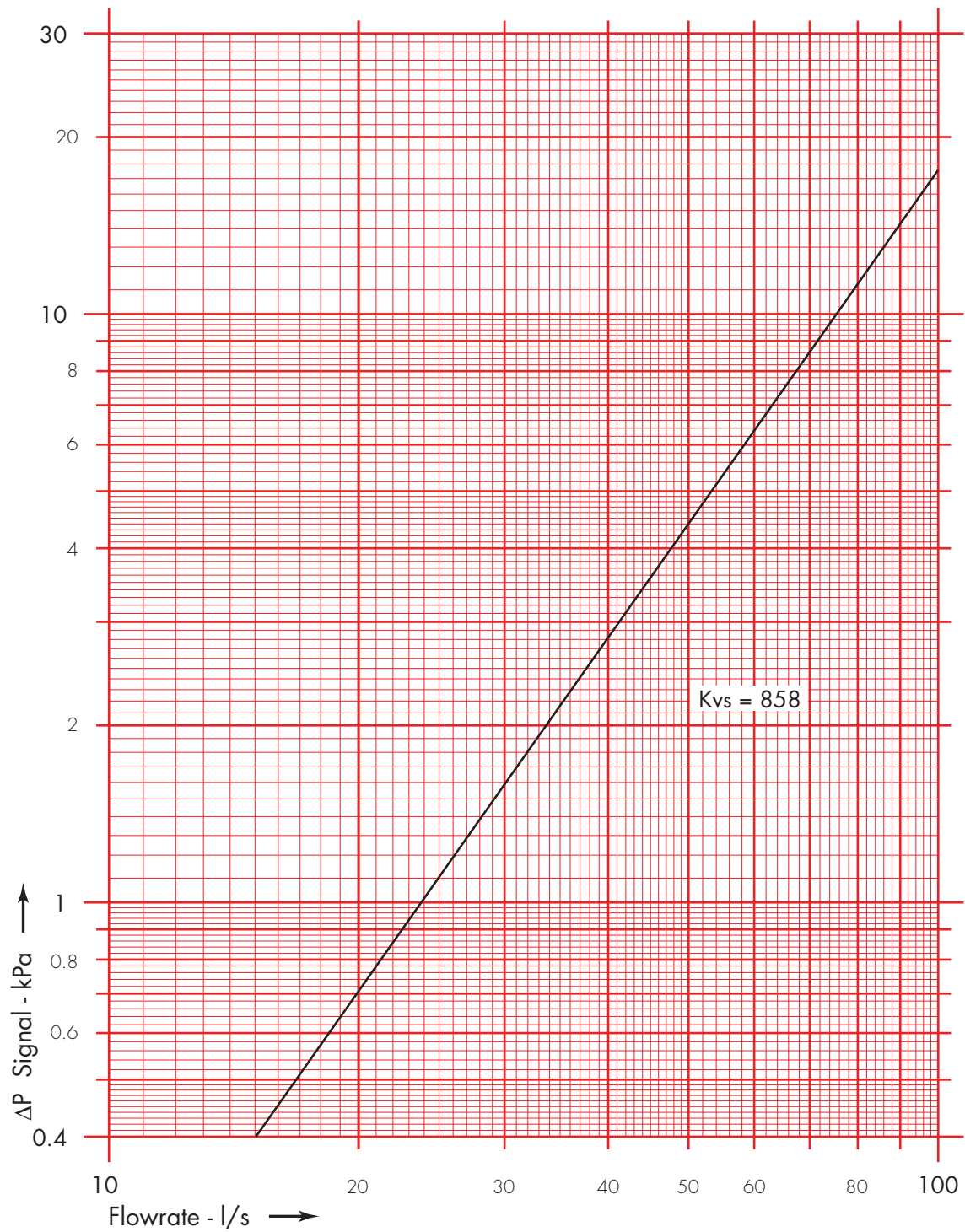

We reserve the right to make design modifications

HERZ Valves UK Ltd.
 Progress House, Moorfield Point, Moorfield Road
 Slyfield Ind Estate, Guildford, Surrey GU1 1RU
 Tel: 01483 502211 e-mail: sales@herzvalves.com
 Fax: 01483 502025 Website: www.herzvalves.com



HERZ - Flow data - pressure drop

Double Regulating Valve

Art. **4218** - 86

Dim. DN200

Position	4	5	6	7	8	9	10	11	12	15
Kv	137	201	266	339	413	472	531	561	591	676

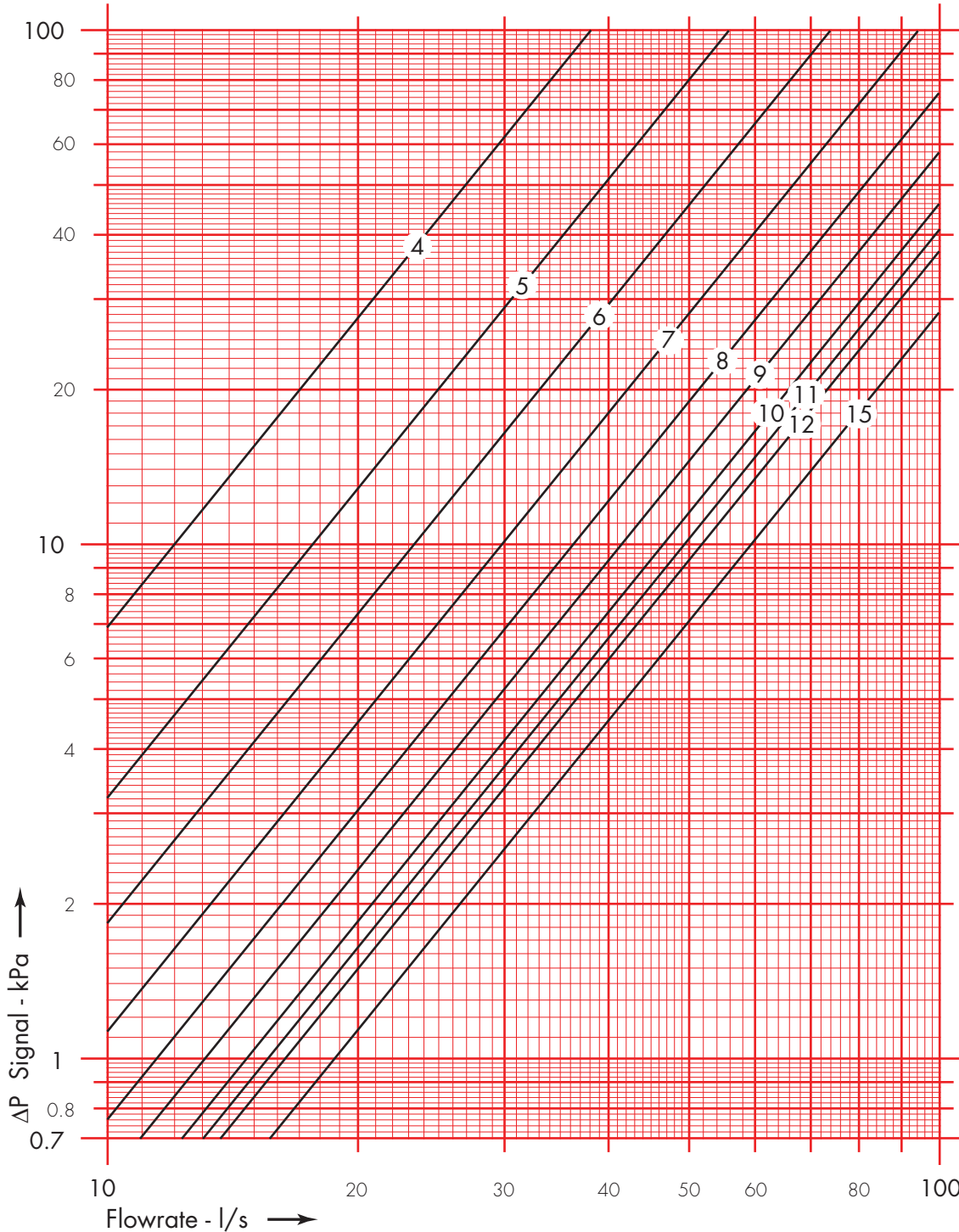

We reserve the right to make design modifications

HERZ Valves UK Ltd.

Progress House, Moorfield Point, Moorfield Road
Slyfield Ind Estate, Guildford, Surrey GU1 1RU

Tel: 01483 502211 e-mail: sales@herzvalves.com

Fax: 01483 502025 Website: www.herzvalves.com



HERZ - Flow data	Stainless Steel Orifice Plate
Art. HV 2740 - 13	Dim. DN250

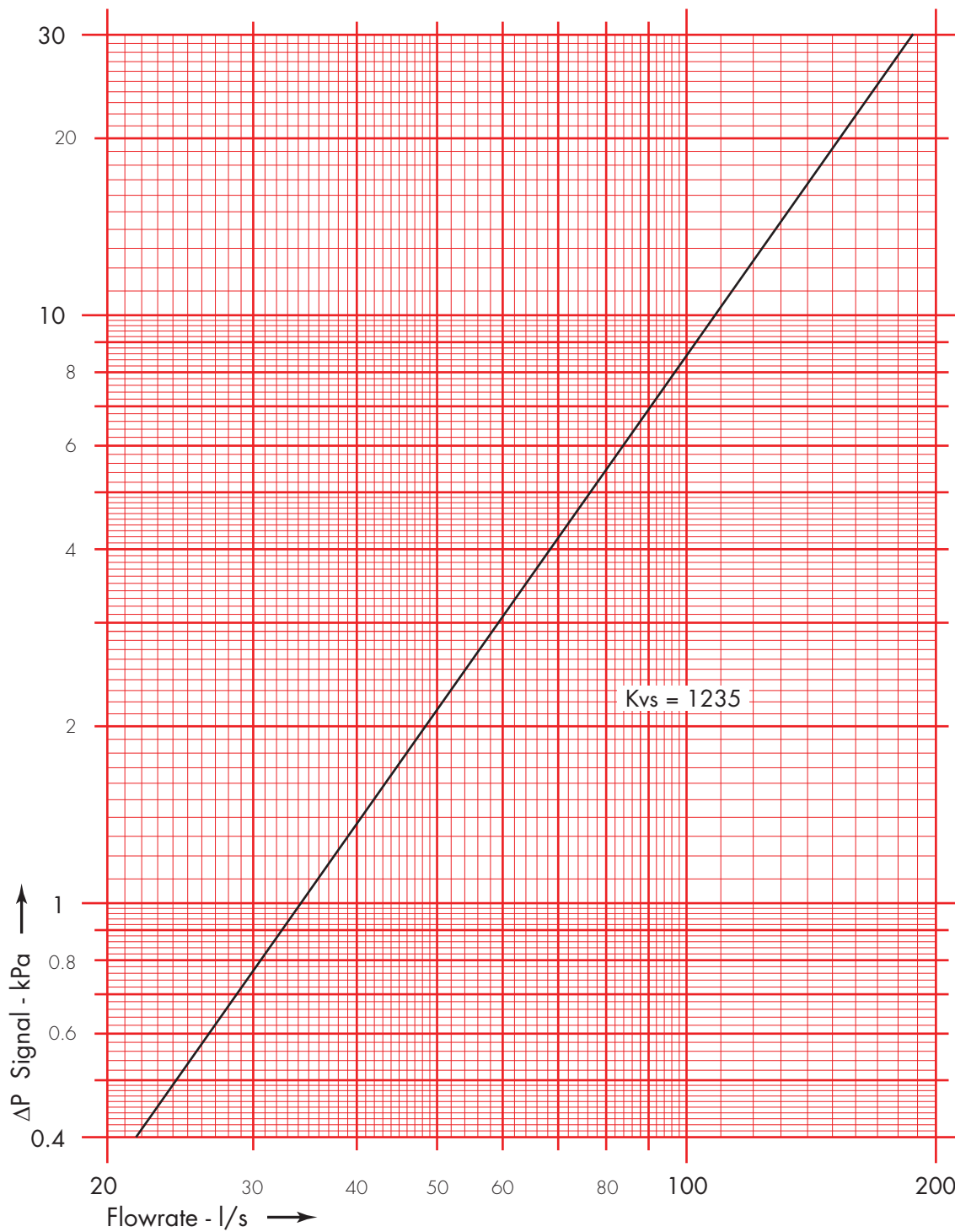

We reserve the right to make design modifications

HERZ Valves UK Ltd.

Progress House, Moorfield Point, Moorfield Road
Slyfield Ind Estate, Guildford, Surrey GU1 1RU

Tel: 01483 502211 e-mail: sales@herzvalves.com

Fax: 01483 502025 Website: www.herzvalves.com



HERZ - Flow data - pressure drop

Double Regulating Valve

Art. **4218** - 87

Dim. DN250

Position	4.5	5	6	7	8	9	10	12	14	18
Kv	195	216	263	317	400	513	597	781	928	1083

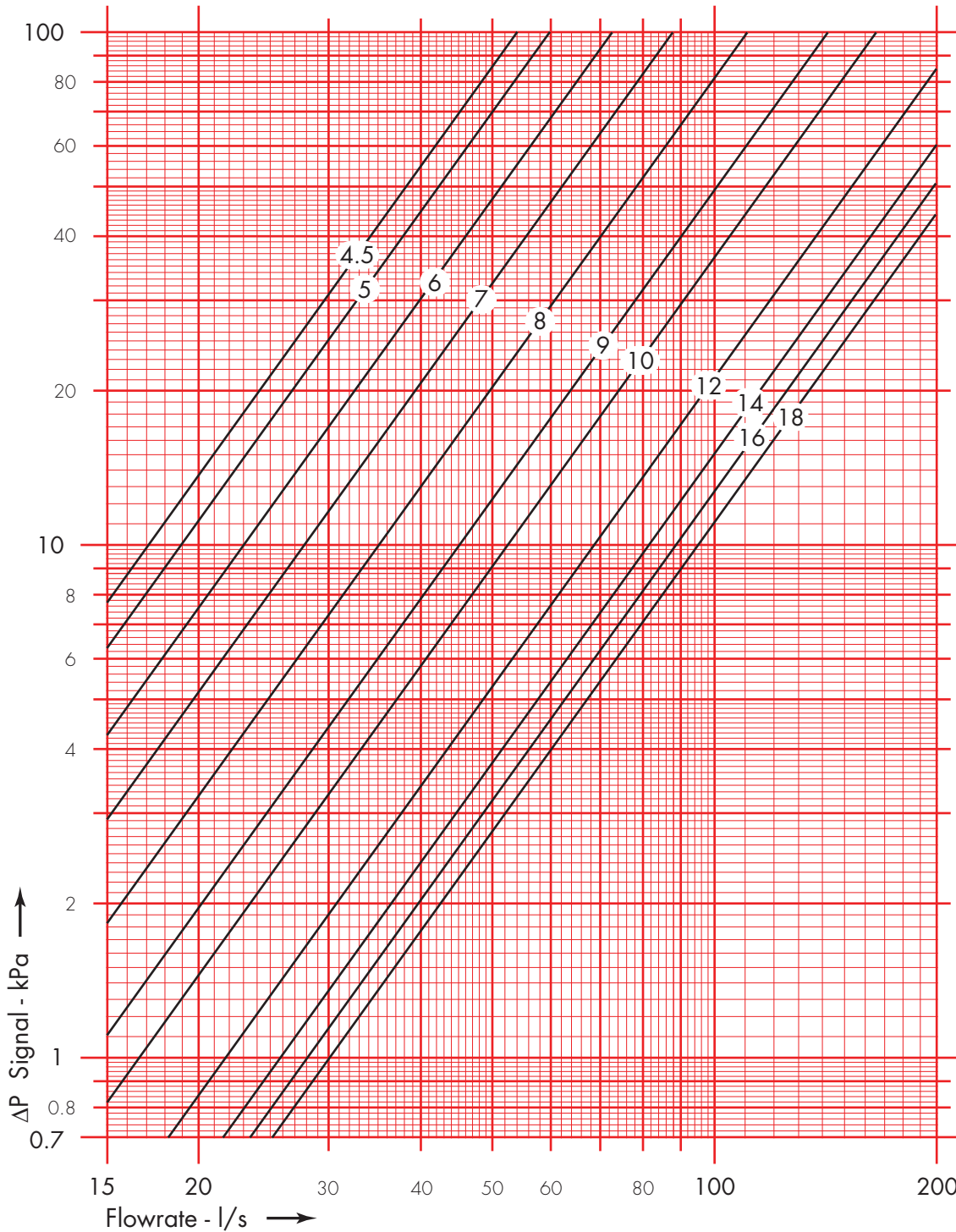

We reserve the right to make design modifications

HERZ Valves UK Ltd.

Progress House, Moorfield Point, Moorfield Road
Slyfield Ind Estate, Guildford, Surrey GU1 1RU

Tel: 01483 502211 e-mail: sales@herzvalves.com

Fax: 01483 502025 Website: www.herzvalves.com



HERZ - Flow data	Stainless Steel Orifice Plate
Art. HV 2740 - 14	Dim. DN300

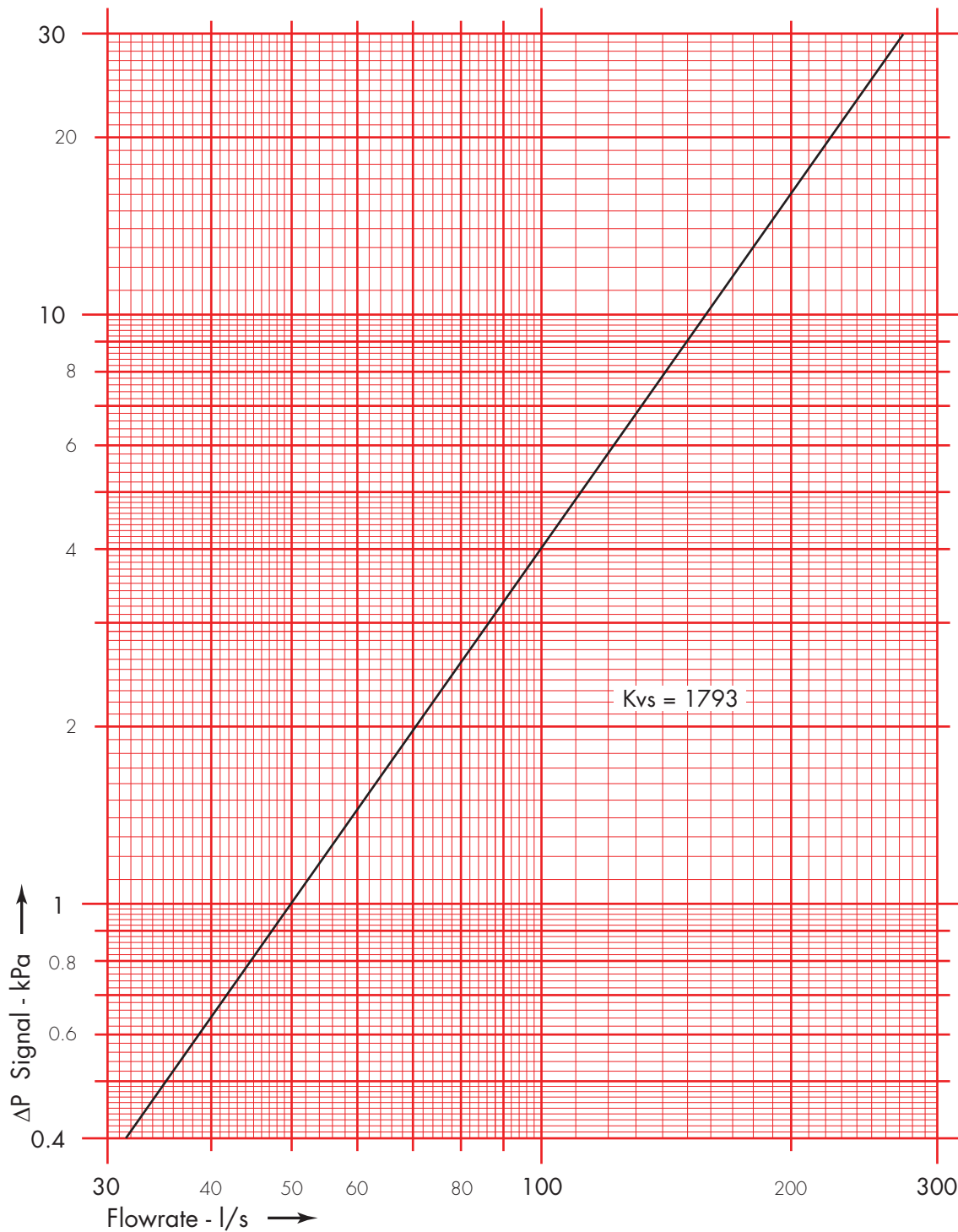

We reserve the right to make design modifications

HERZ Valves UK Ltd.

Progress House, Moorfield Point, Moorfield Road
Slyfield Ind Estate, Guildford, Surrey GU1 1RU

Tel: 01483 502211 e-mail: sales@herzvalves.com

Fax: 01483 502025 Website: www.herzvalves.com



HERZ - Flow data - pressure drop

Double Regulating Valve

Art. **4218** - 88

Dim. DN300

Position	5.5	6	7	8	9	10	12	14	18	22
Kv	272	302	346	389	521	664	907	1111	1529	1785

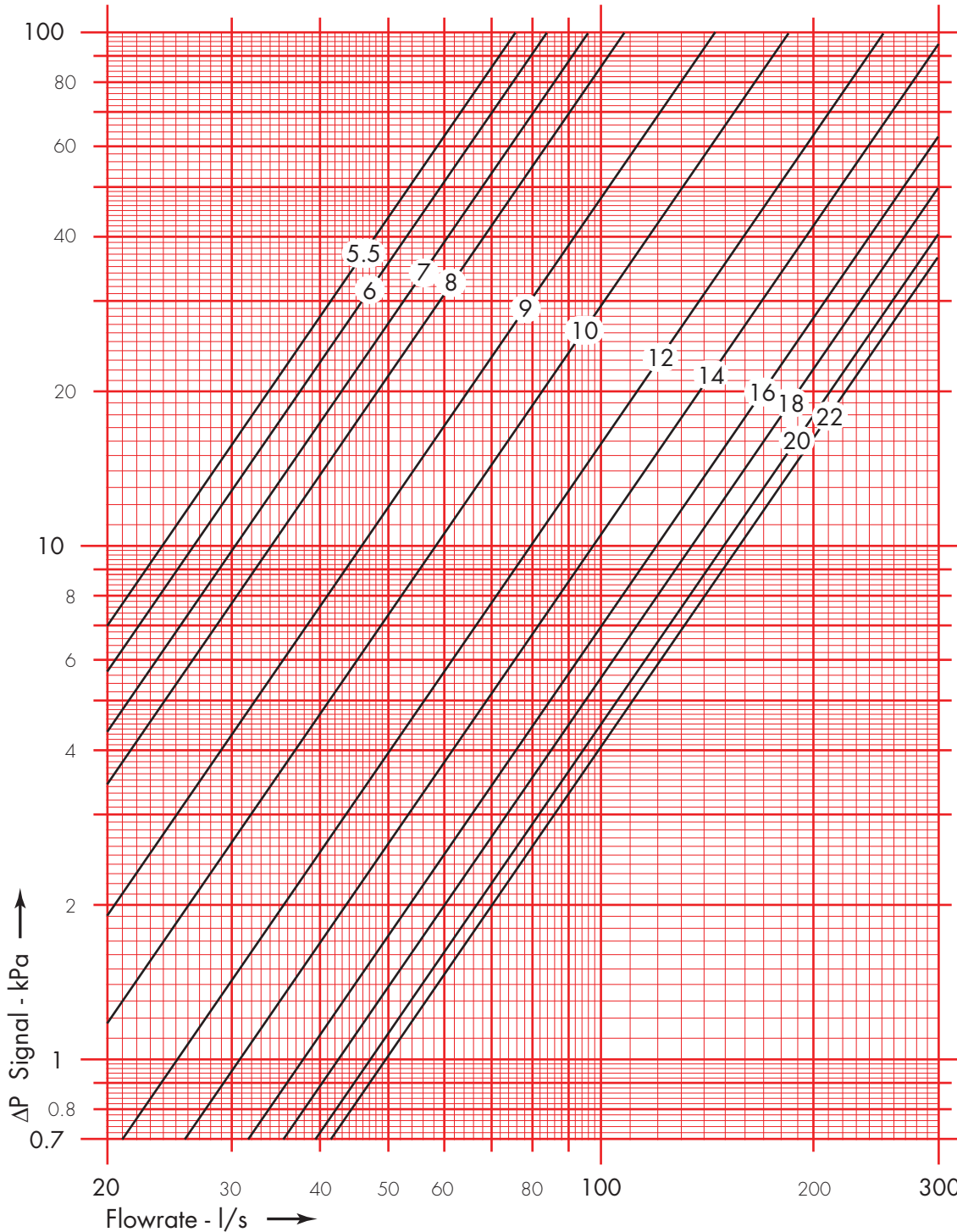

We reserve the right to make design modifications

HERZ Valves UK Ltd.

Progress House, Moorfield Point, Moorfield Road
Slyfield Ind Estate, Guildford, Surrey GU1 1RU

Tel: 01483 502211 e-mail: sales@herzvalves.com

Fax: 01483 502025 Website: www.herzvalves.com

