

# versatile

Heating | Cooling | Ventilation |  
Bathrooms & Tiles

## Versatile ComfoWell 320



# Comfowell 320

The Versatile ComfoWell 320 is a modular system consisting of attenuators, fine grade filters and active carbon filters all integrated for use with a rigid or semi-rigid ductwork approach. With a width of 320mm it can be used for connecting up to 6 ComfoTube connections. The systems compact dimensions ensure good sound absorption and also make it easy to clean. Rigid pipe can be connected to the end plate securely by utilising the gasket seal connection. All other components are fitted using the locking slide connections to form an air tight and robust seal.

Noise reduction can be improved by combining two attenuators together. Filters are available in ISO ePM1 >80% (F7) or ISO ePM1 >90% (F9) grade in addition to an odour neutralising active carbon filter.

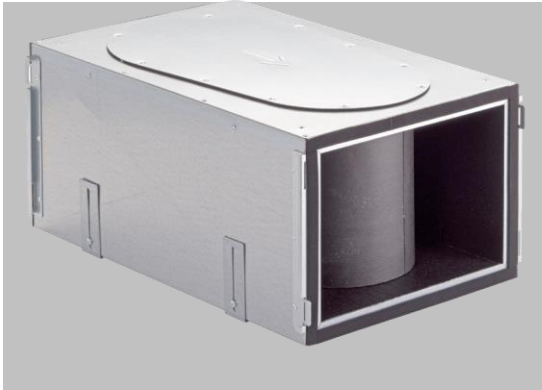

## Key Features

- Attenuator, fine grade filter, active carbon filter and manifold all combined into one space saving combination with the option to bespoke build exactly what is required.
- Easy to assemble thanks to its modular and compact design.

## Article Numbers

Description	Product Code
<b>Attenuator</b>	
Versatile ComfoWell attenuator, CW-S 320	990 323 501
<b>Manifold</b>	
Versatile ComfoWell manifold box CW-D 320	990 323 533
<b>Filter Housing</b>	
Versatile ComfoWell filter housing CW-F 320	990 323 551
<b>Mounting Plates</b>	
Versatile ComfoWell mounting plate, CW-M 320, 6 x 75mm connections	990 323 612
Versatile ComfoWell mounting plate, CW-M 320, 6 x 90mm connections	990 323 613
Versatile ComfoWell mounting plate, CW-M 320, 2 x 90mm + 4 x 75mm connections	990 323 616
<b>End Plates</b>	
Versatile ComfoWell end plate, CW-P 320, $\varnothing$ 125mm	990 323 511
Versatile ComfoWell end plate, CW-P 320, $\varnothing$ 150mm	990 323 562
Versatile ComfoWell end plate, CW-P 320, $\varnothing$ 160mm	990 312 512
Versatile ComfoWell end plate, CW-P 320, $\varnothing$ 180mm	990 312 527

## Article Numbers

### Spacer Frame

Versatile ComfoWell spacer frame, CW-DF 320	990 323 538
---	-------------

### Mounting Set

Versatile ComfoWell mounting set, CW-K 320, for Versatile ComfoAir 160	990 323 570
Versatile ComfoWell mounting set, CW-K 320, for Versatile ComfoAir 200	990 323 517
Versatile ComfoWell mounting set, CW-K 320, for Versatile ComfoAir Q350	990 323 647











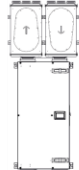

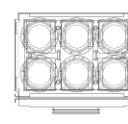
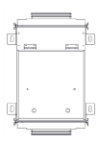
### Filters

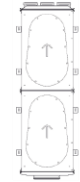
Filter for ComfoWell 320, CW-F7 320, ISO ePM1 >80% (F7), 1 Piece	990 323 603
Filter for ComfoWell 320, CW-F9 320, ISO ePM1 >90% (F9), 1 Piece	990 323 604
Filter for ComfoWell 320, CW-AC 320, active carbon filter, 1 Piece	990 323 605

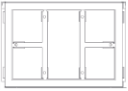
## Technical Specification

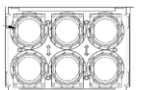
Housing material	Galvanised Sheet Steel
Operating temperature range	-25 to +60 °C
Inner lining	Closed-cell melamine resin foam
Recommended maximum air volume	66.6l/s (240 m <sup>3</sup> /h) at normal ventilation level
Air tightness class to EN 1507:2006	B
Air tightness class to EN 12237:2003	B
Fire rating to ISO13501	C

## Example Connections

Combination Options  Individual Components	ComfoAir 200 Left handed with mounting set, 2 x attenuators and 2 x 6 port ø 75mm mounting plates 	Stand alone attenuator with 2x ø 160mm end plates 	Stand alone manifold with 1 x ø 125mm end plate and 6 x ø 75mm mounting plate 	Stand alone filter housing with 2 x ø 160mm end plate 	Stand alone attenuator and manifold combined with 1 x ø 160mm end plate and 6 x ø 75mm mounting plate 	Stand alone 2 x attenuator with 1 x ø 160mm end plate and 6 x ø 75mm mounting plate 
<b>Silencer</b>  Article Number: 990 323 501	2 x Zehnder ComfoWell attenuator, CW-S 320	1 x Zehnder ComfoWell attenuator, CW-S 320	—	—	1 x Zehnder ComfoWell attenuator, CW-S 320	2 x Zehnder ComfoWell attenuator, CW-S 320
<b>Manifold Box</b>  Article Number: 990 323 531	—	—	1 x Zehnder ComfoWell manifold box, CW-D 320	—	—	—
<b>Filter Housing</b>  Article Number: 990 323 551	—	—	—	1 x Zehnder ComfoWell filter housing, CW-F 320	—	—
<b>Mounting Plate -ø75</b>  Article Number: 990 323 612	2 x Zehnder ComfoWell mounting plate, CW-M 320, 6 x 75mm connections	—	1 x Zehnder ComfoWell mounting plate, CW-M 320, 6 x 75mm connections	—	1 x Zehnder ComfoWell mounting plate, CW-M 320, 6 x 75mm connections	1 x Zehnder ComfoWell mounting plate, CW-M 320, 6 x 75mm connections
<b>End Plate - ø 125</b>  Article Number: 990 323 511	—	—	1 x Zehnder ComfoWell end plate, CW-P 320, ø 125mm	—	—	—
<b>End Plate - ø160</b>  Article Number: 990 323 512	—	2 x Zehnder ComfoWell end plate, CW-P 320, ø 125mm	—	2 x Zehnder ComfoWell end plate, CW-P 320, ø 160mm	1 x Zehnder ComfoWell end plate, CW-P 320, ø 160mm	1 x Zehnder ComfoWell end plate, CW-P 320, ø 160mm
<b>Mounting Set 200</b>  Article Number: 990 323 517	1 x Zehnder ComfoWell mounting set, CW-K 320, for Zehnder ComfoAir 160	—	—	—	—	—
<b>Filter</b>  Article Number: 990 323 604	—	—	—	1 x Filter for ComfoWell 320, CW-F9 320, ISO ePM1 >90% (F9), 1 Piece	—	—

## Dimensions

### Versatile ComfoWell attenuator, CW-S 320

Article number: 990 323 501

#### Description

##### Attenuator:

Versatile ComfoWell attenuator CW-S 320. Rectangular compact attenuator with highly efficient sound insulation combined with low pressure losses. The attenuator can be used individually or in combination with all ComfoWell components. The airtight connection between components is via a clamping strip.

For cleaning purposes the sound absorbing element can be removed.

Mounting on the wall or ceiling is done using the supplied fully adjustable installation mounts.

#### Dimensions

Height	506mm
Width	336mm
Depth	232.5mm
Weight	6.6 kg

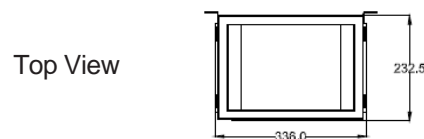
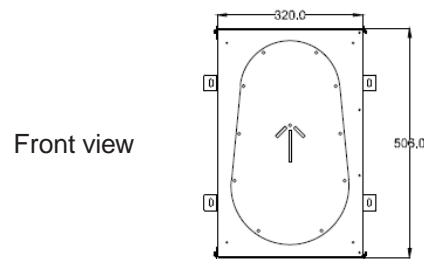
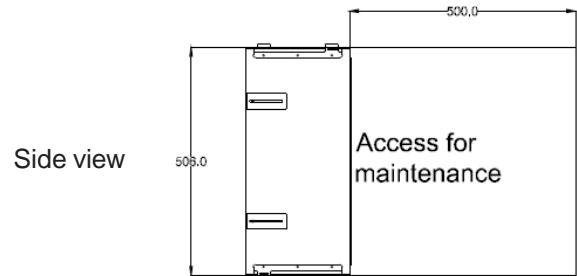

### Versatile ComfoWell manifold box CW-D 320

Article number: 990 323 531

#### Description

##### Manifold Box:

Versatile ComfoWell manifold box CW-D 320. Rectangular compact design with closed pore internal lining. Suitable for use with the mounting plate for ComfoTube 75mm x 6 connections, 90mm x 6 connections or a combination of 90mm x 2 and 75mm x 4 connections. The mounting plate can be mounted on the top or side of the manifold box. The airtight connection between components is via a clamping strip.

For cleaning purposes the manifold box side plate can be removed for easy access. Mounting on the wall or ceiling is done using the supplied fully adjustable installation mounts.

#### Dimensions

Height	233mm
Width	336mm
Depth	253.8mm
Weight	4.52 kg

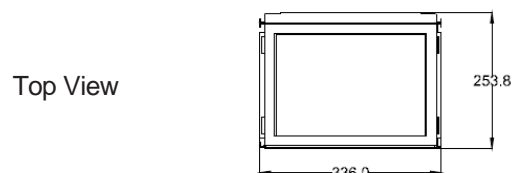
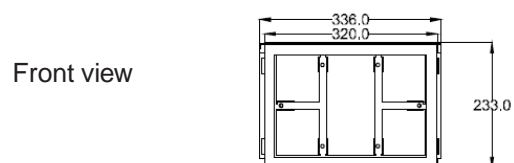
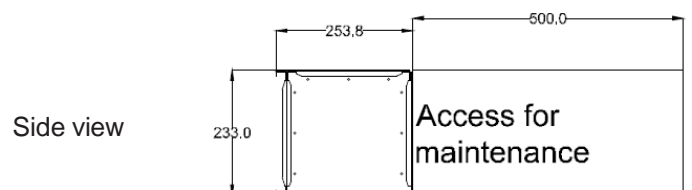

## Dimensions

### Versatile ComfoWell filter housing CW-F 320

Article number: 990 323 551

#### Description

##### Filter Housing:

Versatile ComfoWell filter housing CW-F 220. Rectangular compact design for use with a fine pollen filter graded ISO ePM1 >80% (F7), a fine dust filter graded ISO ePM1 >90% (F9) or an active carbon filter to neutralise odours in the supply air duct run.

The filter elements are not included with the filter housing and need to be purchased separately. The filter housing can be used individually or in combination with all ComfoWell components.

The airtight connection between components is via a clamping strip.

Mounting on the wall or ceiling is done using the supplied fully adjustable installation mounts.

#### Dimensions

Height	306mm
Width	336mm
Depth	242.2mm
Weight	4.73 kg



Side view

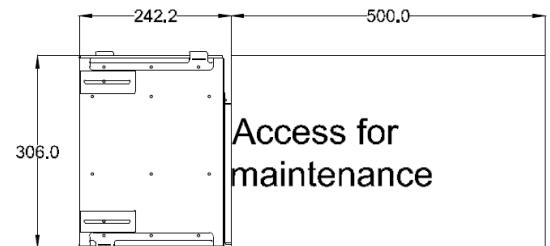

Front view

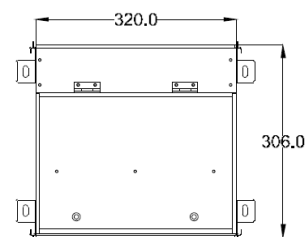

Top View

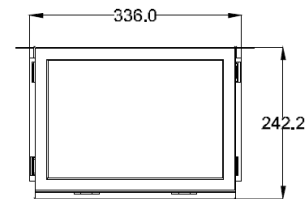

### Versatile ComfoWell mounting plate CW-M 320

Article number: 990 323 612

#### Description

##### Mounting Plate:

Versatile ComfoWell mounting plate CW-M 320-6 x 75. Manifold mounting plate for connection of 6 x ComfoTube 75mm semi-rigid ducting. The mounting plate includes a protective film and the necessary mounting accessories.

#### Dimensions

Height	45.1mm
Width	336mm
Depth	230mm
Weight	<1.53 kg



Side view

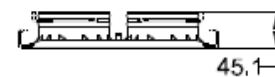

Front view



Top View

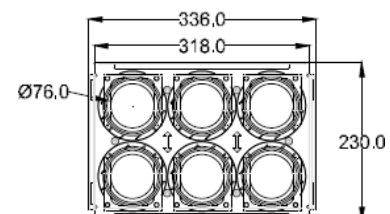

## Dimensions

### Versatile ComfoWell mounting plate CW-M 320

Article number: 990 323 613

#### Description

##### Mounting Plate:

Versatile ComfoWell mounting plate CW-M 320-6 x 90. Manifold mounting plate for connection of 6 x ComfoTube 90mm semi-rigid ducting. The mounting plate includes a protective film and the necessary mounting accessories.

#### Dimensions

Height	45.1mm
Width	336mm
Depth	230mm
Weight	<1.53 kg



Side view



Front view



Top View

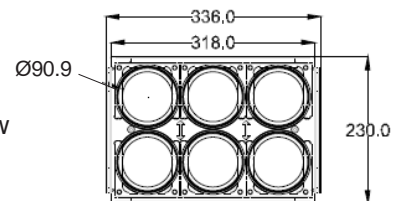

### Versatile ComfoWell mounting plate CW-M 320

Article number: 990 323 616

#### Description

##### Mounting Plate:

Versatile ComfoWell mounting plate CW-M 2 x 90 and 4 x 75. Manifold mounting plate for connection of 2 x 90 and 4 x 75 semi-rigid ducting. The mounting plate includes a protective film and the necessary mounting accessories.

#### Dimensions

Height	45.1mm
Width	336mm
Depth	230mm
Weight	<1.53 kg



Side view



Front view



Top View

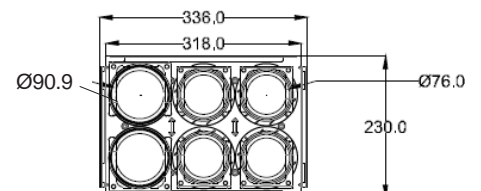

## Dimensions

### Versatile ComfoWell end plate CW-P 320 - $\varnothing$ 125

Article number: 990 323 511

#### Description

#### End Plate:

Versatile ComfoWell end plate CW-P 320 - DN125 (with centre connection) for the connection to the ComfoWell attenuator/manifold box or filter housing to the matching ducting size required. The end plate includes the necessary mounting accessories.

#### Dimensions

Height	42.3mm
Width	336mm
Depth	230mm
Diameter	125mm

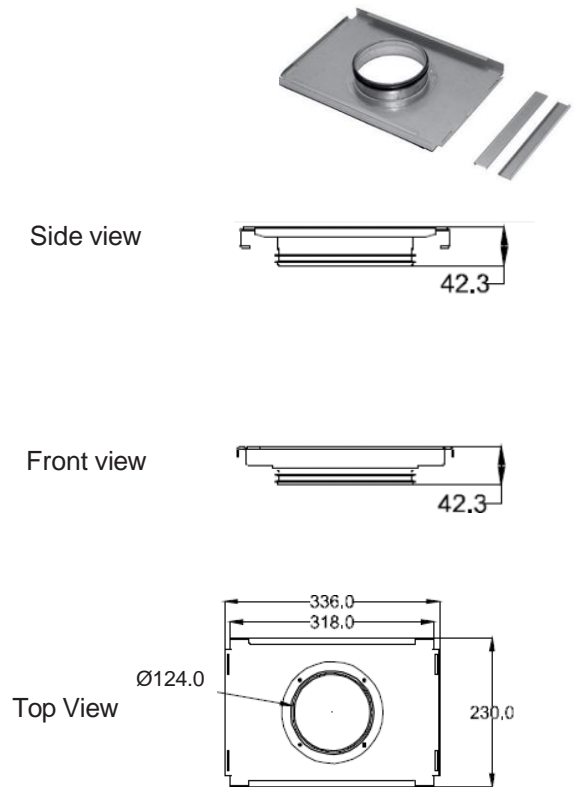

### Versatile ComfoWell end plate CW-P 320 - $\varnothing$ 150mm

Article number: 990 323 562

#### Description

#### End Plate:

Versatile ComfoWell end plate CW-P 320 - DN150 (with centre connection) for the connection to the ComfoWell attenuator/manifold box or filter housing to the matching ducting size required. The end plate includes the necessary mounting accessories.

#### Dimensions

Height	42.3mm
Width	336mm
Depth	230mm
Diameter	150mm

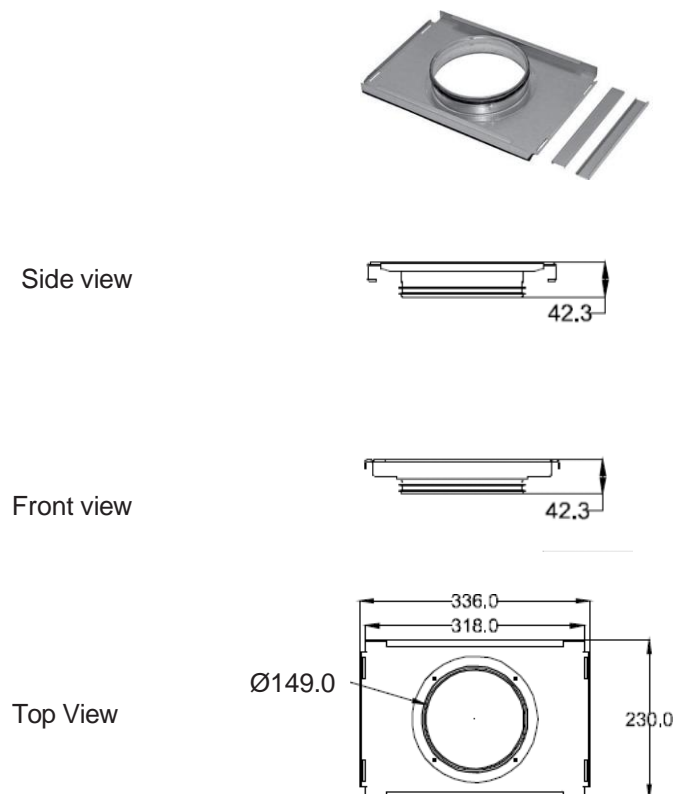



## Dimensions

### Versatile ComfoWell end plate CW-P 320 -Ø 160mm

Article number: 990 323 512

#### Description

#### End Plate:

Versatile ComfoWell end plate CW-P 320 - DN160 (with centre connection) for the connection to the ComfoWell attenuator/manifold box or filter housing to the matching ducting size required. The end plate includes the necessary mounting accessories.

#### Dimensions

Height	42.3mm
Width	236mm
Depth	230mm
Diameter	160mm

Side view

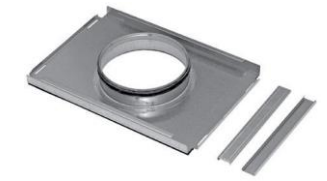

Front view



Top View

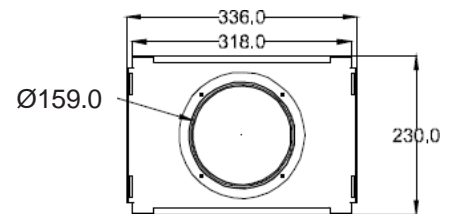

### Versatile ComfoWell end plate CW-P 320 -Ø 180mm

Article number: 990 323 527

#### Description

#### End Plate:

Versatile ComfoWell end plate CW-P 320 - DN180 (with centre connection) for the connection to the ComfoWell attenuator/manifold box or filter housing to the matching ducting size required. The end plate includes the necessary mounting accessories.

#### Dimensions

Height	42.3mm
Width	236mm
Depth	230mm
Diameter	180mm

Side view

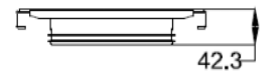

Front view



Top View

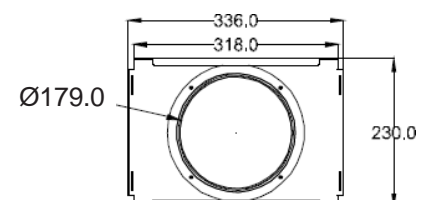

## Dimensions

### Versatile ComfoWell spacer frame, CW-DF 320

Article number: 990 323 538

#### Description

Versatile ComfoWell spacer frame CW-DF320. Rectangular frame for use in the event of uneven surfaces when connecting components and mounting plate (concreted in place) are at 90 degrees. The spacer frame includes the necessary mounting accessories.

#### Dimensions

Height	27.8mm
Width	336mm
Depth	230mm
Weight	1.02 kg



Side view

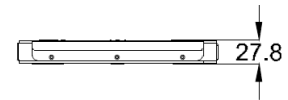

Front view



Top View

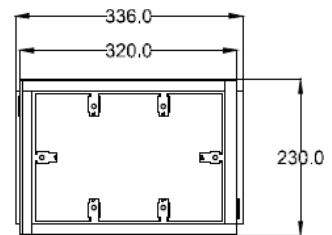

### Versatile ComfoWell mounting set, CW-K 320, for Versatile ComfoAir 160

Article number: 990 323 570

#### Description

##### Mounting set:

A special mounting set is available for the Versatile ComfoWell 320 for direct mounting to the ComfoAir 160 ventilation unit.

The mounting set includes all the necessary accessories (screws, brackets and mounting brackets)



Side view

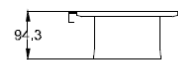

Front view

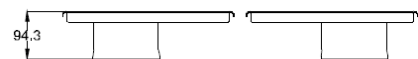

#### Dimensions

Height	94.3mm
Width	336mm
Depth	230mm
Weight	2.3 kg

Top View

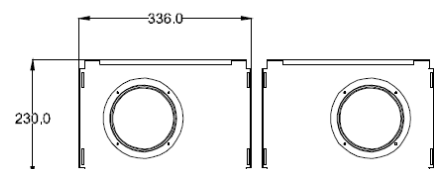

## Dimensions

### Versatile ComfoWell mounting set, CW-K 320, for Versatile ComfoAir 200

Article number: 990 323 517

#### Description

##### Mounting set:

A special mounting set is available for the Versatile ComfoWell 320 for direct mounting to the ComfoAir 200 ventilation unit.

The mounting set includes all the necessary accessories (screws, brackets and mounting brackets)

#### Dimensions

Height	42mm
Width	336mm
Depth	230mm
Weight	1.8 kg

Side view



Front view



Top View

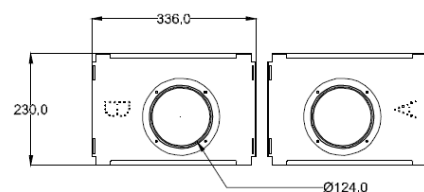

### Versatile ComfoWell mounting set, CW-K 320, for Versatile ComfoAirQ 350

Article number: 990 323 647

#### Description

##### Mounting set:

A special mounting set is available for the Versatile ComfoWell 320 for direct mounting to the ComfoAir Q 350 ventilation unit.

The mounting set includes all the necessary accessories (screws, brackets and mounting brackets)

#### Dimensions

Height	61.8mm
Width	336mm
Depth	510.5mm
Weight	3.5 kg

Side view

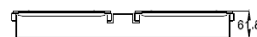

Front view

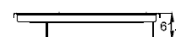

Top View

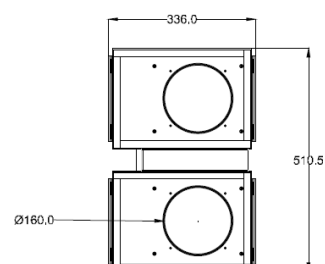

## Pressure Curve

### Comfowell 320

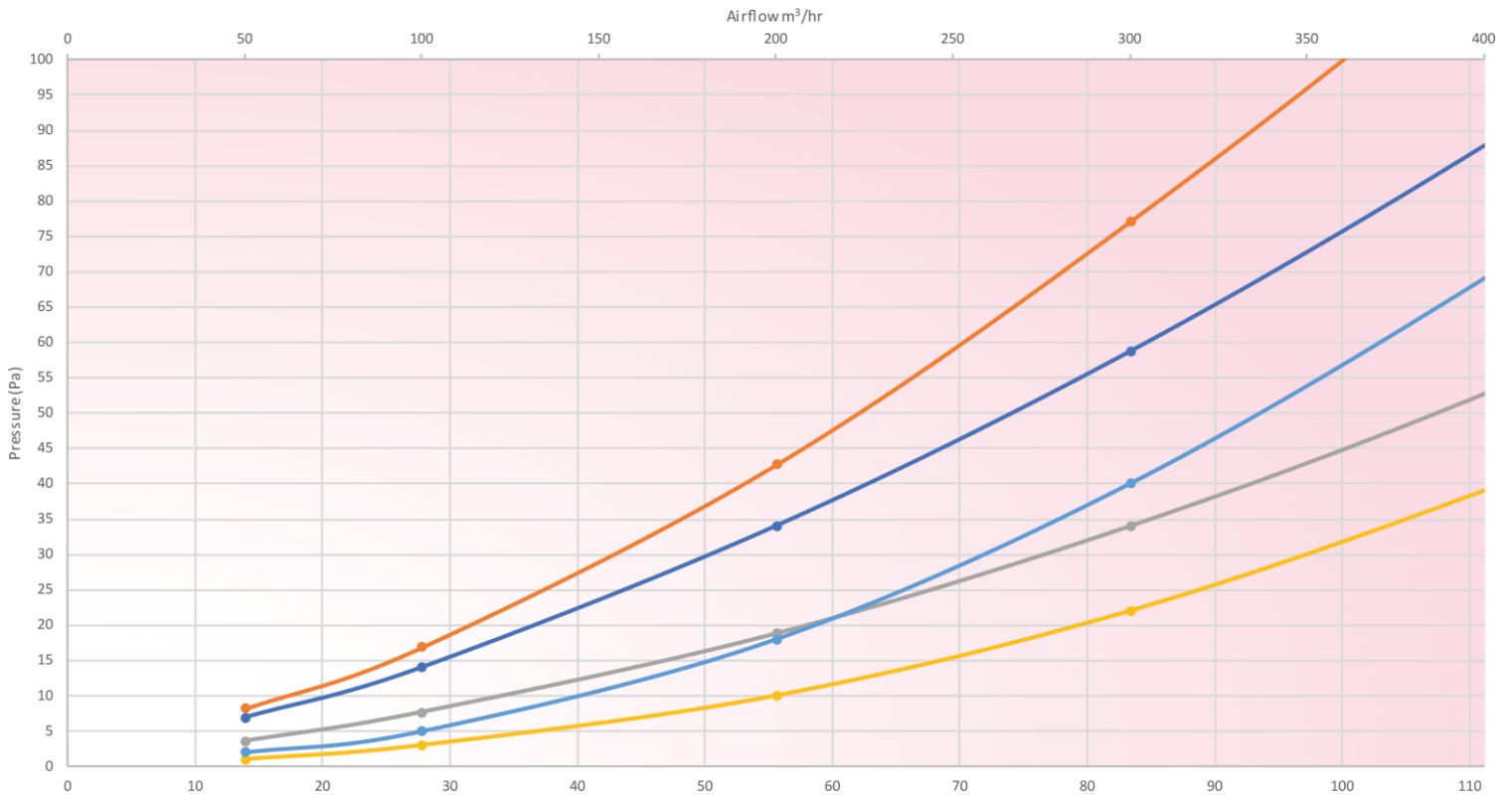

1 x Attenuator (CW-S 320) with 2 x 160mm end plates (CW-P 320)



1 x Filter housing (CW-F 320) with 2 x 160mm end plates (CW-P 320) and filter (CW-F7 320)



2 x Attenuator (CW-S 320) stacked with 2 x 160mm end plates (CW-P 320)



1 x Filter housing (CW-F 320) with 2 x 160mm end plates (CW-P 320) and filter (CW-AC 320)



1 x Filter housing (CW-F 420) with 2 x 160mm end plates (CW-P 420) and filter (CW-F9 320)



## Sound Data

### Comfowell 320

Combination	Octave Band (Hz) Insertion Loss, dB							
	63	125	250	500	1000	2000	4000	8000
1 x Attenuator (CW-S 320) with 2 x 160mm end plates (CW-P 320)	4,6	5,6	9,2	6,5	4,6	23,0	17,4	23,8
2 x Attenuator (CW-S 320) stacked with 2 x 160mm end plates (CW-P 320)	6,0	10,4	17,8	14,1	13,6	47,4	36,8	34,9

## Consultant specification

### Specification

The semi-rigid ductwork manifold shall be constructed of galvanised sheet steel with a closed-cell melamine resin foam inner lining to prevent dust collection and have a fire class C rating according to EN ISO13501.

It shall be of modular construction with options to combine attenuators, manifold box, filter housing with ISO ePM1 >80% (F7), ISO ePM1 >90% (F9) or active carbon filters and end plates ranging from ø 125mm to ø 200mm.

It shall have the option of a mounting set for direct connection to the mechanical ventilation with heat recovery unit. The components shall be tested to BS EN 1507:2006 and BS EN 12237:2003 for airtightness and have removable elements to provide access for cleaning.

versatile

Heating | Cooling | Ventilation |  
Bathrooms & Tiles